

SERVICE MANUAL

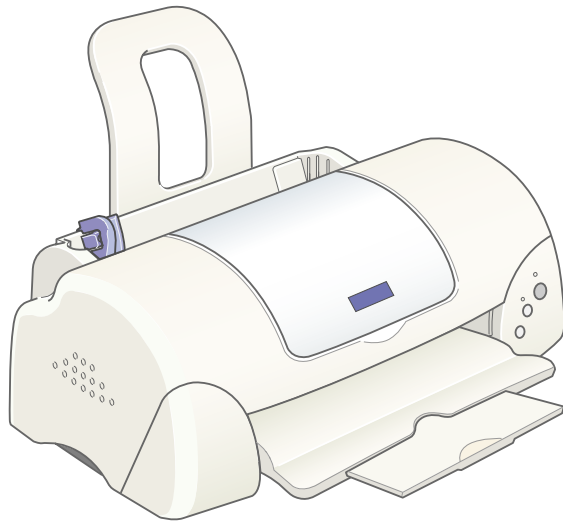

Color Inkjet Printer

EPSON STYLUS COLOR 680/777/777i



EPSON®

Notice

- All rights reserved. No part of this manual may be reproduced, stored in a retrieval system, or transmitted in any form or by any means electronic, mechanical, photocopying, or otherwise, without the prior written permission of SEIKO EPSON CORPORATION.
- All effort have been made to ensure the accuracy of the contents of this manual. However, should any errors be detected, SEIKO EPSON would greatly appreciate being informed of them.
- The contents of this manual are subject to change without notice.
- All effort have been made to ensure the accuracy of the contents of this manual. However, should any errors be detected, SEIKO EPSON would greatly appreciate being informed of them.
- The above notwithstanding SEIKO EPSON CORPORATION can assume no responsibility for any errors in this manual or the consequences thereof.

EPSON is a registered trademark of SEIKO EPSON CORPORATION.

General Notice: Other product names used herein are for identification purpose only and may be trademarks or registered trademarks of their respective owners. EPSON disclaims any and all rights in those marks.

Copyright © 2000 SEIKO EPSON CORPORATION. Printed in Japan.

PRECAUTIONS

Precautionary notations throughout the text are categorized relative to 1) Personal injury and 2) damage to equipment.

DANGER Signals a precaution which, if ignored, could result in serious or fatal personal injury. Great caution should be exercised in performing procedures preceded by ***DANGER*** Headings.

WARNING Signals a precaution which, if ignored, could result in damage to equipment.

The precautionary measures itemized below should always be observed when performing repair/maintenance procedures.

DANGER

1. ALWAYS DISCONNECT THE PRODUCT FROM THE POWER SOURCE AND PERIPHERAL DEVICES PERFORMING ANY MAINTENANCE OR REPAIR PROCEDURES.
2. NO WORK SHOULD BE PERFORMED ON THE UNIT BY PERSONS UNFAMILIAR WITH BASIC SAFETY MEASURES AS DICTATED FOR ALL ELECTRONICS TECHNICIANS IN THEIR LINE OF WORK.
3. WHEN PERFORMING TESTING AS DICTATED WITHIN THIS MANUAL, DO NOT CONNECT THE UNIT TO A POWER SOURCE UNTIL INSTRUCTED TO DO SO. WHEN THE POWER SUPPLY CABLE MUST BE CONNECTED, USE EXTREME CAUTION IN WORKING ON POWER SUPPLY AND OTHER ELECTRONIC COMPONENTS.

WARNING

1. REPAIRS ON EPSON PRODUCT SHOULD BE PERFORMED ONLY BY AN EPSON CERTIFIED REPAIR TECHNICIAN.
2. MAKE CERTAIN THAT THE SOURCE VOLTAGES IS THE SAME AS THE RATED VOLTAGE, LISTED ON THE SERIAL NUMBER/ RATING PLATE. IF THE EPSON PRODUCT HAS A PRIMARY AC RATING DIFFERENT FROM AVAILABLE POWER SOURCE, DO NOT CONNECT IT TO THE POWER SOURCE.
3. ALWAYS VERIFY THAT THE EPSON PRODUCT HAS BEEN DISCONNECTED FROM THE POWER SOURCE BEFORE REMOVING OR REPLACING PRINTED CIRCUIT BOARDS AND/OR INDIVIDUAL CHIPS.
4. IN ORDER TO PROTECT SENSITIVE MICROPROCESSORS AND CIRCUITRY, USE STATIC DISCHARGE EQUIPMENT, SUCH AS

About This Manual

This manual describes basic functions, theory of electrical and mechanical operations, maintenance and repair procedures of EPSON Stylus Color 680/777/777i. The instructions and procedures included herein are intended for the experienced repair technicians, and attention should be given to the precautions on the preceding page.

Contents

This manual consists of six chapters and one Appendix.

CHAPTER 1.PRODUCT DESCRIPTIONS

Provides a general overview and specifications of the product.

CHAPTER 2.OPERATING PRINCIPLES

Describes the theory of electrical and mechanical operations of the product.

CHAPTER 3.TROUBLESHOOTING

Provides the step-by-step procedures for the troubleshooting.

CHAPTER 4.DISASSEMBLY AND ASSEMBLY

Describes the step-by-step procedures for disassembling and assembling the product.

CHAPTER 5.ADJUSTMENTS

Provides Epson-approved methods for adjustment.

CHAPTER 6.MAINTENANCE

Provides preventive maintenance procedures and the lists of Epson-approved lubricants and adhesives required for servicing the product.

APPENDIXProvides the following additional information for reference:

- Connector pin assignments
- Electric circuit boards components layout
- Exploded diagram
- Electrical circuit boards schematics

Symbols Used in This Manual

Various symbols are used throughout this manual either to provide additional information on a specific topic or to warn of possible danger present during a procedure or an action. Be aware of all symbols when they are used, and always read WARNING, CAUTION or NOTE messages.



Indicates an operating or maintenance procedure, practice or condition that, if not strictly observed, could result in injury or loss of life.



Indicates an operating or maintenance procedure, practice, or condition that, if not strictly observed, could result in damage to, or destruction of, equipment.



May indicate an operating or maintenance procedure, practice or condition that is necessary to accomplish a task efficiently. It may also provide additional information that is related to a specific subject, or comment on the results achieved through a previous action.

Revision Status

Revision	Issued Date	Description
A	August 10, 2000	First Release
B	August 31, 2000	Revision: <ul style="list-style-type: none">■ Added disassembly and reassembly caution to 4.2.1 Housing Removal■ Changed the resolution of bit map images when producing PDF files for clearer reading.

Chapter 1 PRODUCT DESCRIPTION

1.1 FEATURES	10
1.2 SPECIFICATIONS.....	11
1.2.1 Physical Specification.....	11
1.2.2 Printing Specification.....	11
1.2.3 Paper Feeding.....	12
1.2.4 Input Data Buffer	12
1.2.5 Electric Specification	12
1.2.6 Environmental Condition	13
1.2.7 Reliability	13
1.2.8 Safety Approvals	13
1.2.9 Acoustic Noise.....	13
1.2.10 CE Marking.....	13
1.3 INTERFACE	14
1.3.1 Parallel Interface (Forward Channel)	14
1.3.2 Parallel Interface (Reserve Channel)	17
1.3.3 USB Interface.....	18
1.3.4 Prevention of Data Transfer Time-out.....	19
1.3.5 Interface Selection.....	19
1.3.6 IEEE1284.4 Protocol.....	19
1.4 OPERATOR CONTROLS	20
1.4.1 Operating Switch	20
1.4.2 Control Panel.....	20
1.4.3 Panel Functions.....	21
1.4.4 Printer Condition and Panel Status	22
1.4.5 Printer Initialization	22
1.4.6 Errors.....	23
1.5 PAPER	24
1.5.1 Paper Handling.....	24
1.5.2 Paper Specification	24
1.5.3 Printing Area.....	26
1.6 INK CARTRIDGE	28
1.6.1 Black Ink Cartridge.....	28
1.6.2 Color Ink Cartridge	28

Chapter 2 Operating Principles

2.1 Overview.....	30
-------------------	----

2.1.1 Printer Mechanism	30
2.1.2 Printhead.....	31
2.1.3 Carriage Mechanism	33
2.1.4 Paper Feeding Mechanism	34
2.1.5 Paper Loading Mechanism (ASF Unit).....	35
2.1.6 Ink System Mechanism	38
2.2 Electrical Circuit Operating Principles	40
2.2.1 C383 PSB/PSE board	40
2.2.2 C383 MAIN Board	43

Chapter 3 Troubleshooting

3.1 Overview	50
3.2 Troubleshooting with LED Error Indications	51

Chapter 4 Disassembly and Assembly

4.1 Overview	62
4.1.1 Precautions	62
4.1.2 Tools	63
4.1.3 Work Completion Check	64
4.2 Disassembly	65
4.2.1 Housing removal	66
4.2.2 Operation Panel removal	67
4.2.3 Printhead removal	68
4.2.4 CR motor removal	71
4.2.5 Waste drain ink pad unit removal	73
4.2.6 Circuit board removal	75
4.2.7 LD Roller removal	79
4.2.8 HP/PE Sensor removal	83
4.2.9 Ink system unit removal (Cap & Pump unit)	85
4.2.10 Paper Eject Roller removal	87
4.2.11 PF motor removal.....	89
4.2.12 CR unit removal	91
4.2.13 Paper feed roller removal.....	94
4.2.14 Disassembling ASF frame unit.....	97

Chapter 5 Adjustment

5.1 Overview	101
--------------------	-----

5.1.1 Required Adjustment.....	101
5.1.2 Adjustment Program feature	102
5.1.3 Adjustment Program Installation Procedure.....	103
5.1.4 Adjustment Program Initial Setting menu	103
5.1.5 Head ID Input.....	103
5.1.6 Bi-D Adjustment	105
5.1.7 USB ID input.....	107
5.1.8 Head Cleaning Operation.....	109
5.1.9 Initial Ink Charge Operation.....	110
5.1.10 Refurbishment for DOA	111
5.1.11 Protection Counter Check/Reset.....	112
5.1.12 Check pattern printing	114
5.1.13 EEPROM check function.....	115
5.1.14 CSIC Information.....	116

Chapter 6 Maintenance

6.1 Overview.....	118
6.1.1 Cleaning	118
6.1.2 Service Maintenance.....	119
6.1.3 Lubrication.....	119

Chapter 7 Appendix

7.1 Connector Summary.....	124
7.1.1 Major Component Unit	124
7.1.2 EEPROM Address Map.....	127
7.2 Component Layout	131
7.3 Exploded Diagram	133
7.4 Parts List.....	138
7.5 Electrical Circuits	141

CHAPTER

1

PRODUCT DESCRIPTION

1.1 FEATURES

The major features of EPSON color inkjet printers EPSON Stylus COLOR 680/777/777i are:

- High Color Print Quality
 - 2880 (H) X 720 (V) dpi printing
 - Four Color Printing (YMCK)
 - Traditional and New Microweave
- Built-in Auto Sheet Feeder
 - Holds 100 cut-sheets (64g/m²)
 - Holds 10 envelopes
 - Holds 1 transparency films
- Two Built-in Interfaces
 - Bi-directional parallel I/F (IEEE-1284 level 1 device)
 - USB
- Windows/Macintosh exclusive

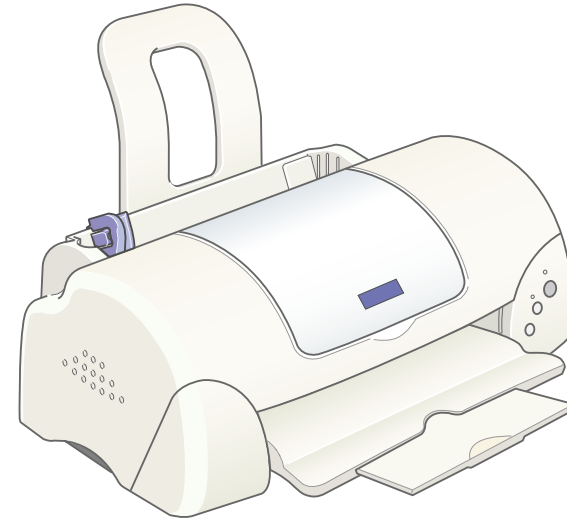

Figure 1-1. External View

1.2 SPECIFICATIONS

This section covers specifications of the printers.

1.2.1 Physical Specification

- Weight: 4.1kg (without ink cartridges)
- Dimension:
 - Storage: 450 mm (W) x 246 mm (D) x 182 mm (H)
 - Printing: 450 mm (W) x 547 mm (D) x 279 mm (H)

1.2.2 Printing Specification

- Print Method
 - On demand ink jet
- Nozzle Configuration
 - Monochrome 144 nozzles (48 x 3 staggered)
 - Color 48 nozzles x 3 (Cyan, Magenta, Yellow)
- Print Direction
 - Bi-direction with logic seeking
- Print Speed & Printable Columns

Table 1-1. Character Mode

Character Pitch	Printable Column	LQ Speed
10 CPI (Pica)	80	238 CPS*

*This value is the speed of normal-dot printing.

Table 1-2. Raster Graphics Mode

Horizontal Resolution	Printable Area	Available Dot	CR Speed
360 dpi	8.26 inches	2976	23.8 IPS
720 dpi	8.26 inches	5952	20 IPS
1440 dpi	8.26 inches	11904	20 IPS

- Control Code
 - ESC/P Raster command
 - EPSON Remote command
- Character Tables
 - Two international character sets:
 - PC 437 (US, Standard Europe)
- Typeface
 - Bit map LQ font:
 - EPSON Courier 10 CPI

1.2.3 Paper Feeding

- Feed Method
 - Friction feed with ASF
- Paper Path
 - Cut-sheet ASF (Top entry, Front out)
- Feed Speed
 - 2.36 inch/sec (Normal, Continuous feed)
 - 4.5 inch/sec (Fast, Continues feed)

1.2.4 Input Data Buffer

- 32KB

1.2.5 Electric Specification

[120V Version]

Rated Voltage:	AC120V
Input Voltage Range:	AC99~132V
Rated Frequency Range:	50~ 60Hz
Input Frequency Range:	49.5~ 60.5Hz
Rated Current:	0.4A
Power Consumption:	Approx. 17W (ISO10561 Letter Pattern) Approx. 2.5W in standby mode Energy Star compliant
Insulation Resistance:	100M ohms min. (between AC line and chassis, DC 500V)
Dielectric Strength:	AC 1000V rms. 1 minutes or AC 1200V rms. 1 second (between AC line and chassis)

[220 ~ 240V Version]

Rated Voltage:	AC220V~240V
Input Voltage Range:	AC198~264V
Rated Frequency Range:	50~60Hz
Input Frequency Range:	49.5~60.5Hz
Rated Current:	0.2 A (for Stylus Color 860) 0.2 A (for Stylus Color 1160)
Power Consumption:	Approx. 17W (ISO10561 Letter Pattern) Approx. 2.5W in standby mode Energy Star compliant
Insulation Resistance:	100M ohms min. (between AC line and chassis, DC 500V)
Dielectric Strength:	AC 1500V rms. 1 minute (between AC line and chassis)

1.2.6 Environmental Condition

- Temperature
 - Operating: 10 to 35°C (see the figure below for condition)
 - Non-operating: -20 to 60°C (with shipment container)
1 month at 40°C and 120 hours at 60°C
- Humidity
 - Operating: 20 to 80% RH
(without condensation / see the figure below for condition)
 - Non-operating: 5 to 85% RH
(without condensation / with shipment container)
- Resistance to Shock
 - Operating: 1G, within 1 ms
 - Non-operating: 2G, within 2 ms (with shipment container)
- Resistance to Vibration
 - Operating: 0.15G
 - Non-operating: 0.50G (with shipment container)

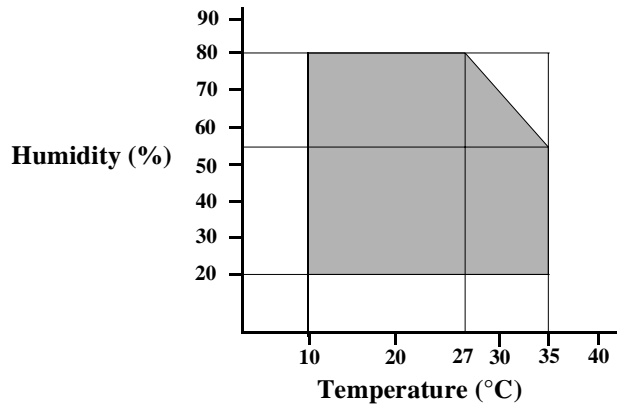

Figure 1-2. Temperature/Humidity Range

1.2.7 Reliability

Total Print Volume: 50,000 pages (A4, Letter)
or 5 years although less than 50.000 pages printing

Print Head Life: 3 billion dots/nozzle

1.2.8 Safety Approvals

[120V Version]
Safety Standards: UL1950
CSA22.2 No.950

EMI: FCC part 15 subpart B Class B
CSA C108.8 Class B

[220~240V Version]
Safety Standards: EN60950 (VDE)

EMI: EN55022 (CISPR Pub.22) Class B
AS/NZS 3548 Class B

1.2.9 Acoustic Noise

Level: Approx. 47dB(A) (According to ISO 7779)
-Used media : Plain Paper
- Print Quality: Fine

1.2.10 CE Marking

[220~240V Version]
Low Voltage Directive 73/23/EEC: EN60950
EMC Directive 89/336/EEC: EN55022 Class B
EN61000-3-2
EN61000-3-3
EN50082-1
IEC801-2
IEC801-3
IEC801-4

1.3 INTERFACE

The EPSON Stylus COLOR 680/777/777i provide USB and parallel interface as standard.

1.3.1 Parallel Interface (Forward Channel)

Transmission Mode: 8 bit parallel, IEEE-1284 compatibility mode
 Synchronization: By STROBE pulse
 Handshaking: BY BUSY and ACKNLG signal
 Signal Level: TTL compatible level
 Adaptable Connector: 57-30360 (amphenol) or equivalent

BUSY signal is set high before setting either -ERROR low or PE high, and held high until all these signals return to their inactive state.

BUSY signal is at high level in the following cases:

- During data entry (see data transmission timing).
- When input data buffer is full.
- During -INIT signal is at low level or during hardware initialization.
- During printer error (see -ERROR signal).
- When the parallel interface is not selected.

ERROR signal is at low level when the printer is in one of the following states:

- Printer hardware error (fatal error)
- Paper-out error
- Paper-jam error
- Ink-out error

PE signal is at high level during paper-out error.

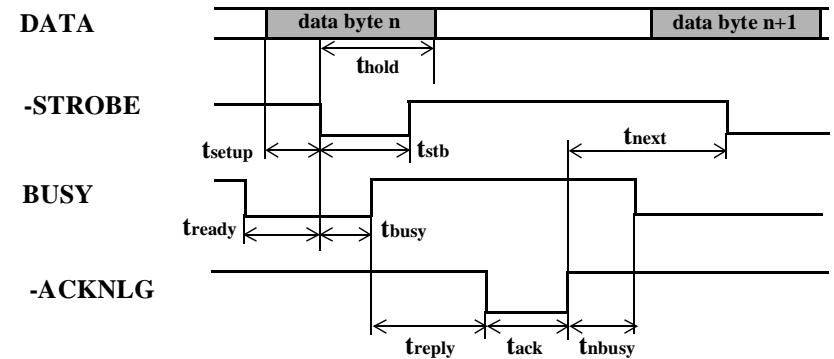

Figure 1-3. Data Transmission Timing

Table 1-3.

Parameter	Minimum	Maximum
tsetup	500ns	-
tthold	500ns	-
tstb	500ns	-
tready	0	-
tbusy	-	500ns
tt-out*	-	120ns
tt-in**	-	200ns
treply	0	-
tack	500ns	10us
tnbusy	0	-
tnext	0	-

* Rise and fall time of every output signal.

** Rise and fall time of every input signal.

*** Typical timing for tack is shown on the following page.

Table 1-4. Typical Time of tack

Parallel I/F Mode	Typical Time of tack
High Speed	0.5us
Normal Speed	2us

Table 1-5. Signal Level: TTL Compatible (IEEE-1284 level 1 device)

Parameter	Minimum	Maximum	Condition
VOH*	-	5.5V	
VOL*	-0.5V	-	
IOH*	-	0.32mA	VOH = 2.4V
IOL*	-	12mA	VOL = 0.4V
CO	-	50pF	
VIH	-	2.0V	
VIL	0.8V	-	
I _{IH}	-	0.32mA	VIH = 2.0V
I _{IL}	-	12mA	VIL = 0.8V
CI	-	50pF	

* A low logic level on the Logic H signal is 2.0V or less when the printer is powered off, and this signal is equal to or exceeding 3.0V when the printer is powered on. The receiver shall provide an impedance equivalent to 7.5K ohm to ground.

Table 1-6. Connector Pin Assignment and Signals

Pin No.	Signal Name	Return GND Pin	In/Out	Functional Description
1	-STROBE	19	In	The strobe pulse. Read-in of data is performed at the falling edge of this pulse.
2	DATA0	20	In	The DATA0 through DATA7 signals represent data bits 0 to 7, respectively. Each signal is at high level when data is logical 1 and low level when data is logical 0.
3	DATA1	21	In	
4	DATA2	22	In	
5	DATA3	23	In	
6	DATA4	24	In	
7	DATA5	25	In	
8	DATA6	26	In	
9	DATA7	27	In	
10	-ACKNLG	28	Out	This signal is a negative pulse indicating that the printer can accept data again.
11	BUSY	29	Out	A high signal indicates that the printer cannot receive data.
12	PE	28	Out	A high signal indicates paper-out error.
13	SLCT	28	Out	Always at high level when the printer is powered on.
14	-AFXT	30	In	Not used.
31	-INIT	30	In	The falling edge of a negative pulse or a low signal on this line causes the printer to initialize. Minimum 50us pulse is necessary.
32	-ERROR	29	Out	A low signal indicates printer error condition.
36	-SLIN	30	In	Not used.
18	Logic H	-	Out	Pulled up to +5V via 3.9 K ohm resistor.

Table 1-6. Connector Pin Assignment and Signals (continued)

Pin No.	Signal Name	Return GND Pin	In/Out	Functional Description
35	+5V	-	Out	Pulled up to +5V via 3.3K ohm resistor.
17	Chassis GND	-	-	Chassis GND
16,33, 19-30	GND	-	-	Signal GND
15,34	NC	-	-	Not connected

NOTE: In/Out refers to the direction of signal flow seen from the printer side.

1.3.2 Parallel Interface (Reserve Channel)

Transmission Mode:	IEEE-1284 nibble mode
Adaptable Connector	See forward channel.
Synchronization:	Refer to the IEEE-1284 specification
Handshaking:	Refer to the IEEE-1284 specification
Data Trans. Timing:	Refer to the IEEE-1284 specification
Signal Level:	IEEE-1284 level 1 device See forward channel.

Table 1-7. Connector Pin Assignment and Signals

Pin No.	Signal Name	Return GND Pin	In/Out	Functional Description
1	HostClk	19	In	Host clock signal.
2	DATA0	20	In	The DATA0 through DATA7 signals represent data bits 0 to 7, respectively. Each signal is at high level when data is logical 1 and low level when data is logical 0. These signals are used to transfer the 1284 extensibility request values to the printer.
3	DATA1	21	In	
4	DATA2	22	In	
5	DATA3	23	In	
6	DATA4	24	In	
7	DATA5	25	In	
8	DATA6	26	In	
9	DATA7	27	In	
10	PtrClk	28	Out	Printer clock signal.
11	PtrBusy / DataBit-3,7	29	Out	Printer busy signal and reverse channel transfer data bit 3 or 7.
12	AckDataReq / DataBit-2,6	28	Out	Acknowledge data request signal and reverse channel transfer data bit 2 or 6.
13	Xflag / DataBit-1,5	28	Out	X-flag signal and reverse channel transfer data bit 1 or 5.
14	HostBusy	30	In	Host busy signal.
31	-INIT	30	In	Not used.

Table 1-7. Connector Pin Assignment and Signals (continued)

Pin No.	Signal Name	Return GND Pin	In/Out	Functional Description
32	-DataAvail / DataBit-0,4	29	Out	Data available signal and reverse channel transfer data bit 0 or 4.
36	1284-Active	30	In	1284 active signal.
18	Logic-H	-	Out	Pulled up to +5V via 3.9K ohm resistor.
35	+5V	-	Out	Pulled up to +5V via 3.3K ohm resistor.
17	Chassis GND	-	-	Chassis GND
16,33, 19-30	GND	-	-	Signal GND
15,34	NC	-	-	Not connected

NOTE: *In/Out* refers to the direction of signal flow from the printer's point of view.

Extensibility Request:

The printer responds affirmatively when the extensibility request values are 00H or 04H, which means,

- 00H: Request Nibble Mode Reverse Channel Transfer.
- 04H: Request Device ID;
Return Data Using Nibble Mode Rev Channel Transfer.

Device ID:

The printer sends the following device ID string when requested.

When IEEE1284.4 is enabled,
 [00H] [5AH]
 MFG: EPSON;
 CMD: ESCPL2, BDC, D4;
 MDL: Stylus[SP]COLOR[SP]XXX*;
 CLS: PRINTER;
 DES: EPSON[SP]Stylus[SP]COLOR[SP]XXX*;

When IEEE1284.4 is disabled,
 [00H] [57H]
 MFG: EPSON;
 CMD: ESCPL2, BDC;
 MDL: Stylus[SP]COLOR[SP]XXX*;
 CLS: PRINTER;
 DES: EPSON[SP]Stylus[SP]COLOR[SP]860/1160;
 *XXX is 777 (for EAI spec) or 680 (for EURO/ASIA spec)

Note 1: [00H] denotes a hexadecimal value of zero.

Note2: MDL value depends on the EEPROM setting.

Note3: CMD value depends on the IEEE1284.4 setting.

1.3.3 USB Interface

Standard:	Based on: “Universal Serial Bus Specifications Rev. 1.0” “Universal Serial Bus Device Class Definition for Printing Devices Version 1.0”
Bit Rate:	12Mbps (Full Speed Device)
Data Encoding:	NRZI
Adaptable Connector:	USB Series B
Recommended Cable Length:	2 meters

Table 1-8. Connector Pin Assignment and Signals

Pin No.	Signal Name	I/O	Function Description
1	VCC	-	Cable power. Max. power consumption is 2mA.
2	-Data	Bi-D	Data
3	+Data	Bi-D	Data, pull up to +3.3 V via 1.5K ohm resistor.
4	Ground	-	Cable ground

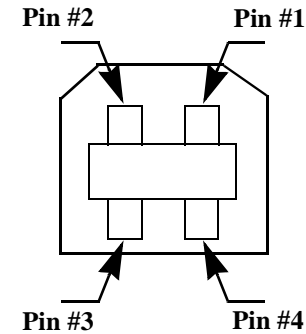

Figure 1-4. USB Pin Assignment

1.3.4 Prevention of Data Transfer Time-out

Generally, hosts abandon data transfer to peripherals when the peripheral is in the busy state for dozens of seconds continuously. To prevent this kind of time-out, the printer receives data very slowly, several bytes per minute, even if the printer is in the busy state. The slowdown starts when the remaining input buffer becomes several hundreds of bytes, and the printer finally gets into the busy state continuously when the input buffer is full.

USB and IEEE1284.4 on the parallel interface do not require such function.

1.3.5 Interface Selection

The printer has two built-in interfaces: the USB and parallel interface.

These interfaces are selected automatically.

Automatic Selection

In this automatic interface selection mode, the printer is initialized to the idle state while scanning which interface receives data when it is powered on. Then the interface which received data first is selected. When the host stops data transfer and the printer is in the stand-by state for seconds, the printer is returned to the idle state. As long as the host sends data or the printer interface is in the busy state, the selected interface is let as it is.

Interface State and Interface Selection

When the parallel interface is not selected, the interface gets into the busy state. When the printer is initialized or returned to the idle state, the parallel interface gets into the ready state. Note that the interrupt signal such as the -INIT signal on the parallel interface is not effective while that interface is not selected.

1.3.6 IEEE1284.4 Protocol

The packet protocol described by IEEE1284.4 standard allows a device to carry on multiple exchanges or conversations which contain data and/or control information with another device at the same time across a single point-to-point link. The protocol is not, however, a device control language. It does provide basic transport-level flow control and multiplexing services. The multiplexed logical channels are independent of each other and blocking of one has no effect on the others. The protocol operates over IEEE1284.

Automatic Selection

An initial state is compatible interface and starts IEEE1284.4 communication when magic strings (1284.4 synchronous commands) are received.

On

An initial state is IEEE1284.4 communication and data that received it by the time it is able to take synchronization by magic string (1284.4 synchronous commands) is discarded.

Off

An initial state is compatible interface and never starts IEEE1284.4 communication even if magic strings (1284.4 synchronous commands) are received.

1.4 OPERATOR CONTROLS

1.4.1 Operating Switch

Operating switch is located on the control panel.

1.4.2 Control Panel

1.4.2.1 Switches

There are two non-lock type push switches, one lock-type push switch, and two LED lights.

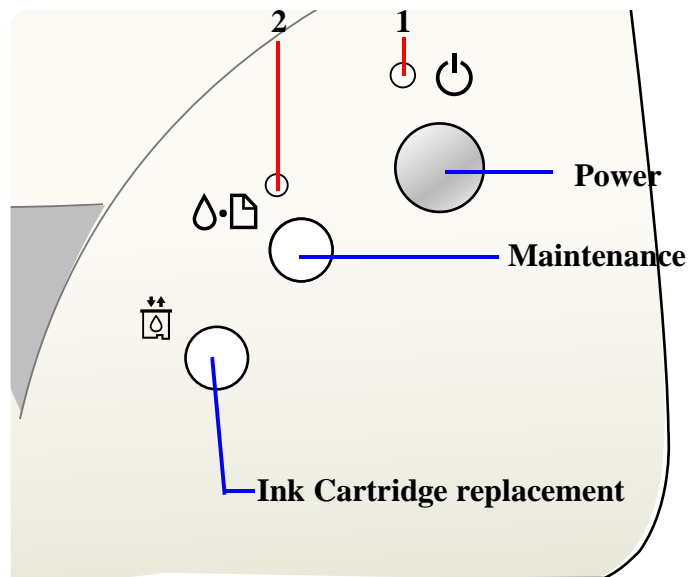

Figure 1-5. Control Panel

1.4.2.2 Indicators

- (1) **Power**
Lights when the operating switch is “ON” and AC power is supplied.
- (2) **Error**
Lights or blinks when some error has occur to the printer.

1.4.3 Panel Functions

Table 1-9. Panel Functions

Switch	Function
Maintenance	<ul style="list-style-type: none"> • Loads or Ejects the Paper (Pushing within 3seconds). • Starts the Cleaning of head (Pushing for 3seconds). • When carriage is on the Ink Cartridge change position, return carriage from Ink Cartridge change position.
Ink Cartridge replacement	<ul style="list-style-type: none"> • Starts the Ink Cartridge change sequence. *

* This function is not available in printing status.

Table 1-10. Panel Functions with Power On

Switch	Function
Maintenance	<ul style="list-style-type: none"> • Start status printings.
Ink Cartridge replacement	<ul style="list-style-type: none"> • Select IEEE 1284.4 mode for parallel I/F. *1
Maintenance + Ink Cartridge replacement	<ul style="list-style-type: none"> • Enters the special setting mode (Factory use only). *3

*1 Not described in the user's manual.

*2 See the table

Table 1-11. Special Setting Mode

Switch	Function
Maintenance	<ul style="list-style-type: none"> • Initialize EEPROM.
Ink Cartridge replacement (10 seconds)	<ul style="list-style-type: none"> • Reset the ink overflow counter in the EEPROM.

1.4.4 Printer Condition and Panel Status

Table 1-12. Printer Condition and LED Status

Printer Status	Indicators		Priority
	Power	Error	
Power ON condition	On	-	10
Ink sequence	Blink	-	6
Ink Cartridge change mode	Blink	-	5
Data processing	Blink	-	9
Paper Out	-	On	4
Paper jam condition	-	On	3
Ink end (Black)	-	On -> Blink	8
Ink level low (Black)	-	Blink	8
Ink end (Color)	-	On -> Blink2	8
Ink level low (Color)	-	Blink	8
Ink end (Black and Color)	-	Blink -> Blink	8
No Ink Cartridge (Black and Color)	-	On	7
Reset, Timer IC reset, EEPROM clear	On (1s)	On (1s)	-
Ink Overflow Counter reset	On (2s)	On (2s)	-
Maintenance request (Ink Overflow Counter error)	Alt Blink	Alt Blink	2
Fatal error	Off	On	1
Special setting	Blink	Blink	-

" - " : Indicator status don't change.

" A -> B " : A is a indicator condition when carriage is on Home Position.

B is a indicator condition in Ink exchange sequence.

1.4.5 Printer Initialization

There are three kinds of initialization methods, and the following explains each initialization.

1. Power-on Initialization
This printer is initialized when turning the printer power on, or printer recognized the cold-reset command (remote RS command).

When printer is initialized, the following actions are performed:

- (a) Initializes printer mechanism.
- (b) Clears input data buffer.
- (c) Clears print buffer.
- (d) Sets default values.

2. Operator Initialization
This printer is initialized when turning the printer power on again within 10 seconds from last power off, or printer recognized the -INIT signal (negative pulse) of parallel interface.

When printer is initialized, the following actions are performed:

- (a) Cap the printer head.
- (b) Eject a paper.
- (c) Clears input data buffer.
- (d) Clears print buffer.
- (e) Sets default values.

3. Software Initialization
The ESC@ command also initialize the printer.

When printer is initialized, the following actions are performed:

- (a) Clears print buffer.
- (b) Sets default values.

1.4.6 Errors

- Ink Out**

When the printer runs out most of the ink of any color, it indicates ink-low and keeps printing. When the printer runs out the whole ink of any color, it stops printing and indicates ink-out error. User is then requested to install a new ink-cartridge in this state. An ink-cartridge that has been taken out once should never be used again. Re-installation of the cartridge not filled fully upsets the ink level detection and may eventually cause a serious problem in the print head.
- Paper Out**

When the printer fails to load a sheet, it goes into a paper out error.
- Paper Jam**

When the printer fails to eject a sheet, it goes into a paper jam error.
- No Ink-Cartridge**

When the printer detects that ink-cartridge comes off, or failed to read or write CSIC data, it goes into this error mode.
- Maintenance Request**

When the total amount of ink wasted through cleanings and flushing reaches to the limit, printer indicates this error and stops. In such a case, the absorber in the printer enclosure needs to be replaced with new one by service personnel.
- Fatal Errors**

Carriage control error.

1.5 PAPER

1.5.1 Paper Handling

Do not perform reverse feed more than 1.8mm (0.07").

1.5.2 Paper Specification

1.5.2.1 Cut Sheet

[Size]

A4:	Width 210mm (8.3") x Length 297mm (11.7")
A5:	Width 148mm (5.8") x Length 210mm (8.3")
A6:	Width 105mm (4.1") x Length 148mm (5.8")
Letter:	Width 216mm (8.5") x Length 279mm (11.0")
Half Letter:	Width 139.7mm (5.5") x Length 216mm (8.5")
B5:	Width 182mm (7.2") x Length 257mm (10.1")
Legal:	Width 216mm (8.5") x Length 356mm (14.0")
Executive:	Width 184.2mm (7.25") x Length 266.7mm (10.5")

[Thickness]

0.08mm (0.003") - 0.11mm (0.004")

[Weight]

64g/m² (17lb.) - 90g/m² (24lb.)

[Quality]

Exclusive paper, Bond paper, PPC

[ASF hopper available capacity]

100 sheets

Note1: No wrinkled, scuffing, torn or folded paper be used.

Note2: No curled paper more than 5 mm be used.

1.5.2.2 Transparency, Glossy Paper

[Size]

A4:	Width 210mm (8.3") x Length 297mm (11.7")
Letter:	Width 216mm (8.5") x Length 279mm (11.0")

[Thickness]

0.075mm (0.003") - 0.085mm (0.0033")

[ASF hopper available capacity]

1 sheets

Note: Transparency printing is available only at normal temperature.

1.5.2.3 Envelope

[Size]

No.10:	Width 241mm (9 1/2") x Length 104.8mm (4 1/8")
DL:	Width 220mm (8.7") x Length 110mm (4.3")
C6:	Width 162mm (6.4") x Length 114mm (4.5")

[Thickness]

0.16mm (0.006") - 0.52mm (0.02")

[Weight]

45g/m² (12lb.) - 75g/m² (20lb.)

[Quality]

Bond paper, Plain paper, Air mail

Note 1: Envelope printing is available only at normal temperature.

Note 2: Keep the longer side of the envelope horizontally at setting.

Note 3: Envelope printing is available only in the normal temperature.

Note 4: No wrinkled, scuffing, torn or folded paper be used.

Note 5: No curled paper more than 5mm be used.

Note 6: No paper with glue on flap be used.

Note 7: No double envelops nor with window envelops be used.

Note 8: Do not print on the back.

1.5.2.4 Index Card**[Size]**

A6 Index Card: Width 105mm (4.1") x Length 148mm (5.8")

A5 Index Card: Width 148mm (5.8") x Length 210mm (8.3")

5 x 8" Index Card: Width 127mm (5.0") x Length 203mm (8.0")

10 x 8" Index Card: Width 127mm (5.0") x Length 203mm (8.0")

[Thickness]

Less than 0.23mm (0.0091")

[ASF hopper available capacity]

30 sheets

1.5.3 Printing Area

1.5.3.1 Cut Sheet

See the figure below and tables on the right for printable areas.

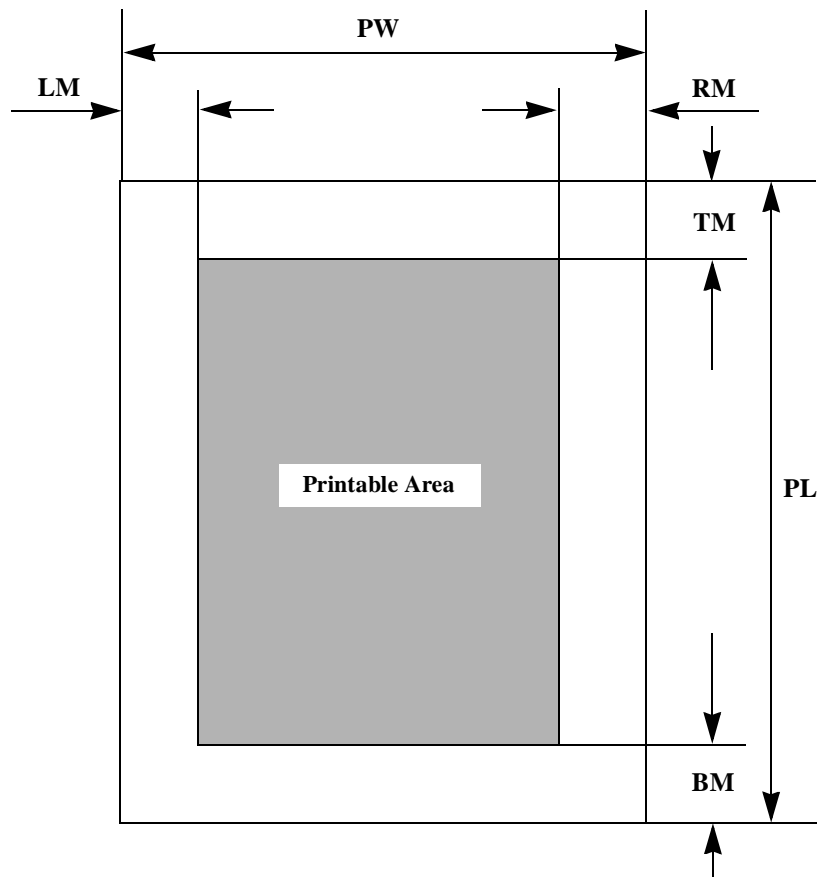

Figure 1-6. Printable Area for Cut Sheet

Table 1-13. Printing Area

Paper Size	Left Margin (min.)	Right Margin (min.)	Top Margin (min.)	Bottom Margin (min.)
A4	3 mm (0.12")	3 mm (0.12")	3 mm (0.12")	14 mm (0.54") / 3mm (0.12") *
Letter	3 mm (0.12")	3 mm (0.12")	3 mm (0.12")	14 mm (0.54") / 3mm (0.12") *
B5	3 mm (0.12")	3 mm (0.12")	3 mm (0.12")	14 mm (0.54") / 3mm (0.12") *
Legal	3 mm (0.12")	3 mm (0.12")	3 mm (0.12")	14 mm (0.54") / 3mm (0.12") *
Statement	3 mm (0.12")	3 mm (0.12")	3 mm (0.12")	14 mm (0.54") / 3mm (0.12") *
Exclusive	3 mm (0.12")	3 mm (0.12")	3 mm (0.12")	14 mm (0.54") / 3mm (0.12") *

- * Bottom margin can be reduced to 3mm when paper dimension is defined by using command, otherwise it is not reduced (14mm). As for an area between 3mm and 14mm margin, printing quality may decline.
- ** Refer to 1.5.2 Paper Specification for PW (paper width) and PL (paper length).

1.5.3.2 Envelopes

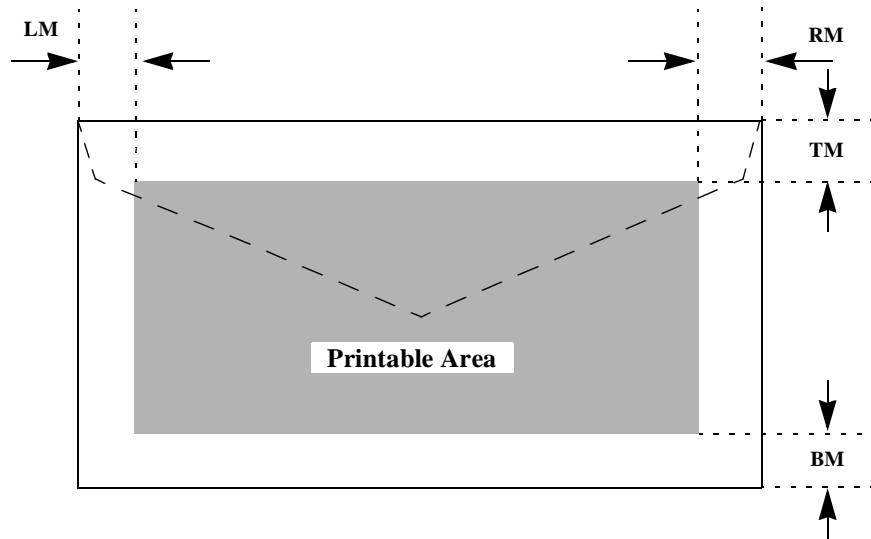

Figure 1-7. Printable Area for Envelopes

Table 1-14. Envelope Margin

Size	Left Margin (min.)	Right Margin (min.)	Top Margin (min.)	Bottom Margin (min.)
#10	3 mm (0.12")	28 mm (1.10")	3 mm (0.12")	14 mm (0.55")
DL	3 mm (0.12")	7 mm (0.28")	3 mm (0.12")	14 mm (0.55")
C6	3 mm (0.12")	3 mm (0.12")	3 mm (0.12")	14 mm (0.55")

1.6 INK CARTRIDGE

1.6.1 Black Ink Cartridge

Type:	Exclusive Cartridge
Color:	Black
Print Capacity:	600 pages/A4 (ISO/IEC 10561 Letter Pattern at 360 dpi)
Ink Life:	2 years from date of production
Storage Temperature:	
Storage:	-20 °C to 40 °C (within a month at 40 °C)
Packing:	-30 °C to 40 °C (within a month at 40 °C)
Transit:	-30 °C to 60 °C (within 120 hours at 60 °C and within a month at 40 °C)
Dimension:	28.1 mm (W) x 66.85 mm (D) x 43.3 mm (H)

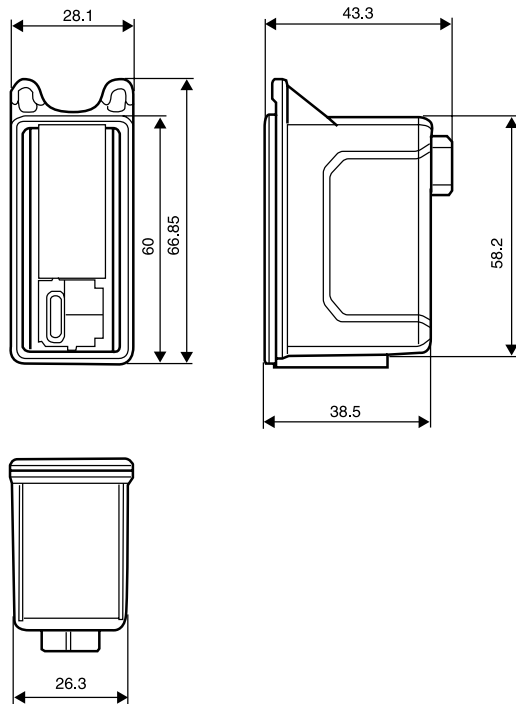

Figure 1-8. Black Ink Cartridge

1.6.2 Color Ink Cartridge

Type:	Exclusive Cartridge
Color:	Magenta, Cyan, Yellow
Print Capacity:	300 pages / A4 (360 dpi, 5% duty each color)
Ink Life:	2 years from date of production
Storage Temperature:	
Storage:	-20 °C to 40 °C (within a month at 40 °C)
Packing:	-30 °C to 40 °C (within a month at 40 °C)
Transit:	-30 °C to 60 °C (within 120 hours at 60 °C and within a month at 40 °C)
Dimension:	43.2 mm (W) x 66.85 mm (D) x 43.3 mm (H)

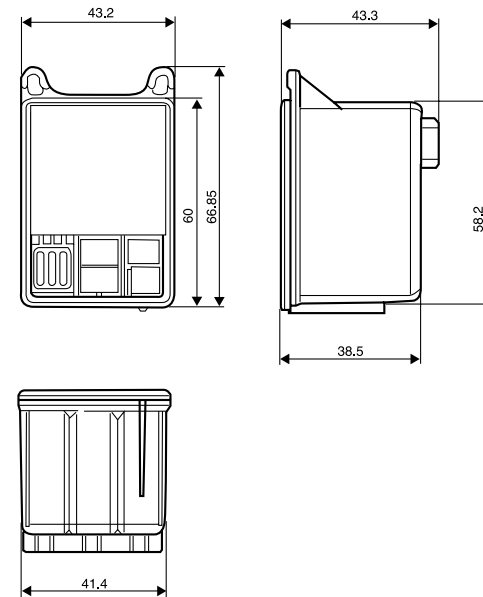

Figure 1-9. Color Ink Cartridge

Note 1: Ink cartridge can not be refilled. The ink cartridge is prepared only for article of consumption.

Note 2: Do not use the ink cartridge which contains life-expired ink.

Note 3: Ink will be frozen under -4 °C environment; however, it will be usable after being left at room temperature for more than three hours.

CHAPTER

2

OPERATING PRINCIPLES

2.1 Overview

This section describes the operating principles of the printer mechanism and electrical circuit boards. The Stylus COLOR 680/777/777i has the following boards:

□ Main board: C383 MAIN (C383 MAIN-B)

NOTE: C383 MAIN-B is compatible with C383 MAIN. Only some chips or parts are different from each other due to different producers.

□ Power supply board: C383 PSB/PSE

□ Panel board: C383 PNL

2.1.1 Printer Mechanism

The printer mechanism for Stylus COLOR 680/777/777i is designed newly. But, the basic component of the printer mechanism is same as previous product.

This printer consists of Print Head, Carriage Mechanism, Paper Feeding Mechanism, Paper Loading Mechanism, Ink System (Pump Mechanism, Cap Mechanism, and Carriage Lock Mechanism).

Like other EPSON ink jet printers, the Stylus COLOR 680/777/777i is equipped with two stepping motors; one for ASF, Paper feeding/ Pump mechanism, and one for CR mechanism. ASF unit uses rear entry front eject system. This ASF unit is also designed newly and single LD roller loads the paper to the printer mechanism.

For cap assembly, Stylus COLOR 680/777/777i uses valveless mechanism; new design for this model.

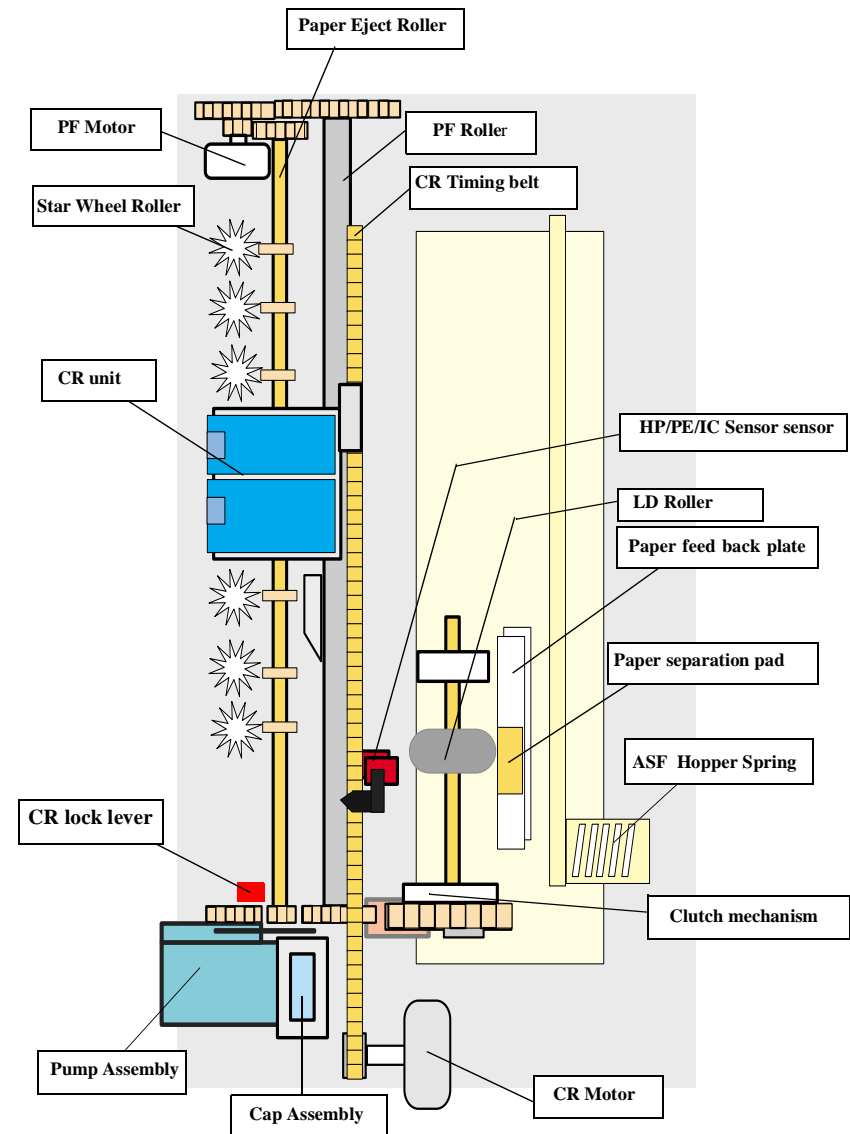

Figure 2-1. Printer Mechanism block diagram

2.1.2 Printhead

The printhead uses a new developed U-CHIPS head and Stylus COLOR 680/777/77i can perform multiple shot printing and variable printing.

The CSIC is mounted on the ink cartridge. By storing ink life data, this IC makes it possible to control the ink in ink cartridge unit.

The basic operating principles of the printhead, which plays a major role in printing, are the same as previous models; on-demand method which uses PZT (Piezo Electric Element). In order to uniform the amount of ejecting ink, the printhead has its own head ID (6 digits for this printhead) which adjust PZT voltage drive features. The printhead stores the head ID to EEPROM and generates appropriate PZT drive voltage to prevent amount of ink from varying by printheads.

Following explains printhead basic components.

- PZT
PZT is an abbreviation of Piezo Electric Element. Certain amount of voltage expands and contracts PTZ. The drive wave generated on MAIN board drives PZT and PZT pushes the top cavity which has ink stored to discharge the ink from each nozzle on the nozzle plate.
- Ink Cavity
The ink absorbed from the ink cartridge goes through the filter and then is stored temporarily in this tank called “cavity” until PZT is driven.
- Nozzle Plate
The board with nozzle holes on the printhead surface is called Nozzle Plate.
- CSIC Connection Circuit
This circuit connects the CSIC mounted on the ink cartridge and the main board. One end of the wire harness connects with the print head cable to the main board.
- Filter
When the ink cartridge is installed, if any dirt or dust around the cartridge needle is absorbed into the head, there is a great possibility of causing nozzle clog and disturbance of ink flow, and finally causing alignment failure and dot missing. To prevent this problem, a filter is set below the cartridge needle, where ink is filtered.

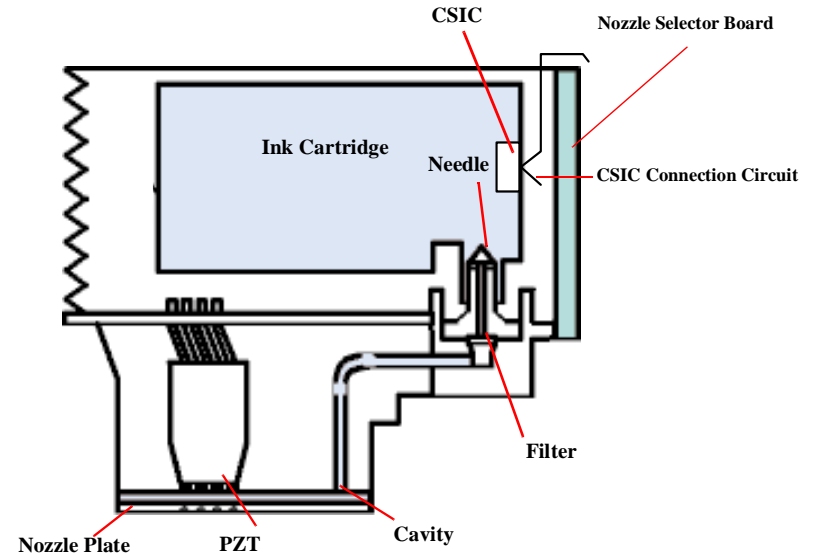

Figure 2-2. Printhead Sectional Drawing

2.1.2.1 Printing Process

This section explains the process in which the printheads of On-Demand inkjet printers eject ink from each nozzle.

1. Normal State:

When no printing signal is sent from PC, or no PZT drive voltage is applied, PZT does not change shape, therefore PZT does not squeeze the cavity. Ink pressure inside the cavity is kept normal. (Refer to Figure 2-3.)

2) Ejecting State:

When the print signal is output from the C383 MAIN board, IC (Nozzle Selector) located on the printhead unit latches data once by 1-byte unit. An appropriate PZT latched by the nozzle selector is pushed into the cavity by the common voltage applied from the main board. By this operation, ink stored in the cavity spurts out from nozzles. (Refer to Figure 2.1.2.2.)

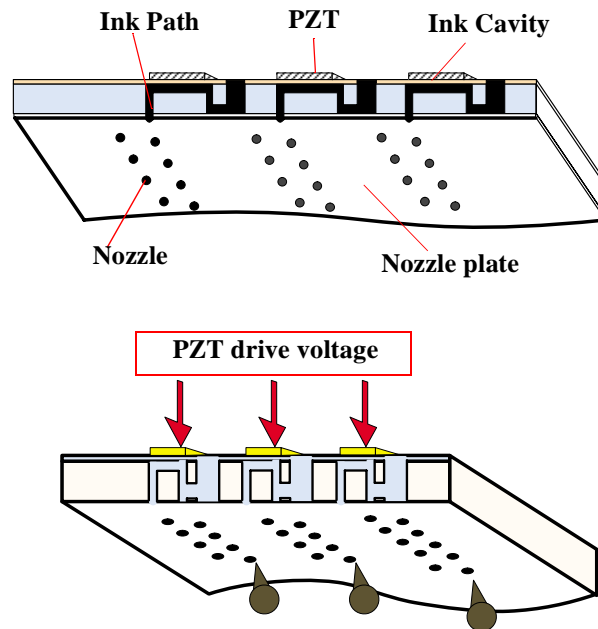

Figure 2-3. Printhead printing process

2.1.2.2 Printing Method

For print dot system, Stylus COLOR 680/777/77i has the following two kinds of printing modes.

- Multiple shot printing
- Variable dot printing

The above two printing modes are automatically selected depending on the media and the resolution setting of the printer driver. The following explains each printing mode.

□ Multiple shot printing

This printing mode is developed to improve the print quality on plain paper or transparencies in low resolution. The multiple shot printing mode uses normal dot and the number of dot shots varies from 1 shot to maximum 4 shots depending on the print data to enable sharp image output even in a low resolution.

□ Variable dot printing

This printing mode is developed to improve the print quality on exclusive paper. This mode is basically the same as variable dot printing mode used on other products /; micro dot, middle dot, and large dot compose this mode. Print dot size varies according to print data and this mode enables even sharper image output on exclusive paper.

2.1.3 Carriage Mechanism

The carriage mechanism consists of Carriage motor (CR motor), Carriage unit (including printhead), CR timing belt, CR guide shaft, CR guide frame, CR home detector (HP/PE sensor) etc. The carriage mechanism moves the carriage back and forth according to the drive from the carriage motor. The following stepping motor is mounted to drive CR mechanism. (See the table below.)

Table 2-1. Carriage Motor Specification

Items	Specifications
Type	4-Phase/ 200-Pole HB Stepping motor
Drive Voltage	+42 V +/- 5% (DRV IC voltage)
Coil Resistance	7.8 Ω +/- 10% (per phase at 25 degree)
Inductance	14 mH +/- 20% (1KH 1VmA)
Drive Method	Bi-Polar drive
Driver IC	LB11847

The drive from CR motor is transferred to the CR unit via CR timing belt. And the CR home position is detected with the HP/PE sensor. This sensor is available as CR HP detector only in the HP (home position) detection sequence & pump operation sequence. (not available in the paper feeding sequence for the CR HP detector because it is used for only PE sensor during the paper feeding sequence.) Moreover, unlike the previous products, this printer dose not have the PG adjustment mechanism (1.7mm).

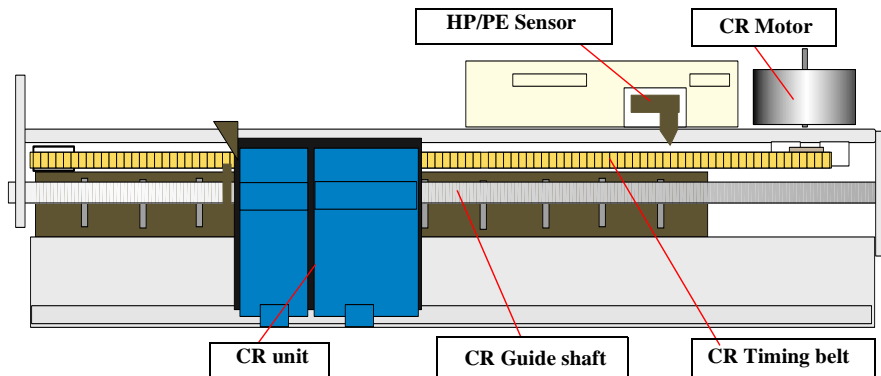

Figure 2-4. Carriage Mechanism (Top view)

CR home position is detected with the HP/PE/IC sensor and the detection plate molded in the CR unit as following figure. When the CR home position is detected with this sensor, HIGH signal is output to the CPU.

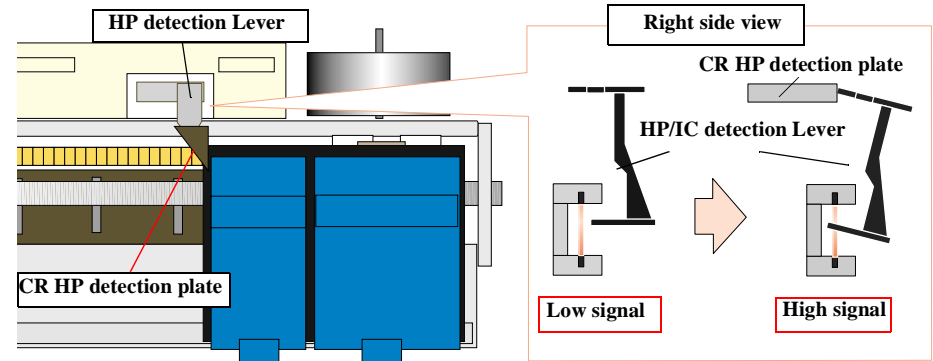

Figure 2-5. CR home position

2.1.4 Paper Feeding Mechanism

The paper feeding mechanism consists of Paper feed motor (PF motor), PF roller, Paper eject roller, Star wheel roller, and so on. The paper feeding mechanism feeds paper loaded from ASF using the PF roller and Paper Eject Roller & Star wheel roller. For this mechanism, the PF motor mentioned in the right Table 2-2 is used on this product.

The drive of the PF motor is transfer to the PF roller and the Paper Eject Roller as following Figure 2-6. Following shows you how to transfer the PF motor drive to the PF roller and the Paper Eject Roller.

□ PF motor drive transmission path

PF Motor Pinion Gear (CW) → Combination Gear 16, 21.6 (CCW) → Spur Gear 73.6 (CW) → Spur Gear 15 (CCW) → Combination Gear 37.6, 44.4 (W) → Spur Gear 23.2 (CCW) → Spur gear 35.2(CW)

Table 2-2. PF Motor Specifications

Item	Description
Motor type	4-Phase/ 200-Pole HB Stepping motor
Drive voltage	+42 V +/- 5% (DRV IC voltage)
Coil Resistance	7.8 Ω +/- 10% (per phase)
Inductance	13.5 mH +/- 20%(1kHz 1Vrms)
Driving method	Bi-Polar drive
Driver IC	LB11847

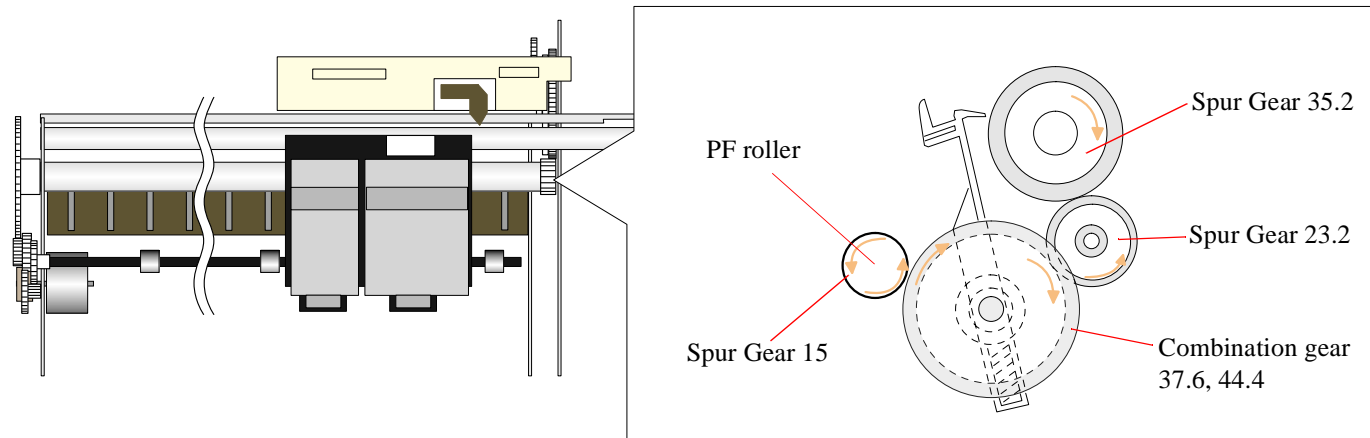

Figure 2-6. Paper Feeding Mechanism

Paper loaded from ASF is advanced by the following roller.

- Paper feed roller & Paper guide roller (assembled on the Top Frame) → Paper eject roller & Star wheel roller (assembled on the Paper eject frame).

Additionally, the top & end of the paper is detected with the HP/PE sensor. In case the PE sensor dose not detect the paper in the paper loading sequence, the printer detects the “Paper out error”. If the paper is detected after complete the paper eject sequence, the printer detects the “Paper jam error”.

2.1.5 Paper Loading Mechanism (ASF Unit)

The Paper loading mechanism is positioned at the printer rear. The Paper loading mechanism loads paper at the ASF unit and feeds paper to the PF roller.

This ASF unit was designed newly for this product and consists of LD roller, Pad holder (Paper return plate), ASF Frame, Hopper, and so on.

For the major feature of this ASF unit, ASF HP sensor is not used and the single LD roller is built in the ASF unit.

Drive sent from the PF motor is always transmitted to the ASF unit side. But, the Change lever and the Clutch mechanism switch ON/OFF the PF motor drive to the LD roller with the motor rotational direction.

Drive from the PF motor is transmitted to the ASF unit as described below:

□ Switch the PF motor drive to ASF unit side

PF Motor pinion gear rotates CCW direction with a specific steps → Combination Gear 16, 21.6 (CW) → Spur Gear 73.6(CCW) → Spur Gear 15(CW) → Combination Gear 37.6, 44.4 (CCW) → Change Lever rotates (CCW) → Release the Clutch mechanism lock position

Following Figure 2-7 shows you the switching path for PF motor drive to ASF unit side.

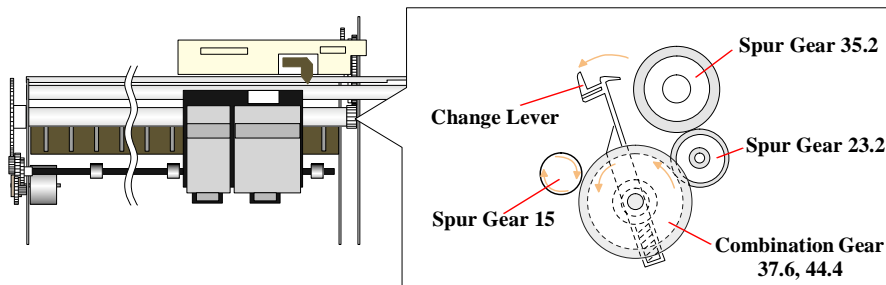

Figure 2-7. Switch the PF motor drive to ASF unit side

□ Transfer the PF motor drive to LD roller

PF Motor pinion gear rotates CW direction → Combination Gear 16, 21.6 (CCW) → Spur Gear 73.6 (CW) → Spur Gear 15 (CCW) → Combination Gear 37.6, 44.4 (CW) → Change Lever rotates (CW) → Spur Gear 23.2 (CCW) → Spur Gear 35.2 (CW) (include the clutch mechanism) → LD roller (CW).

Following Figure 2-9 shows the PF motor drive transmission path to the LD roller unit built in the ASF unit. The LD roller is assembled on the same shaft that the Spur gear 35.2 is assembled.

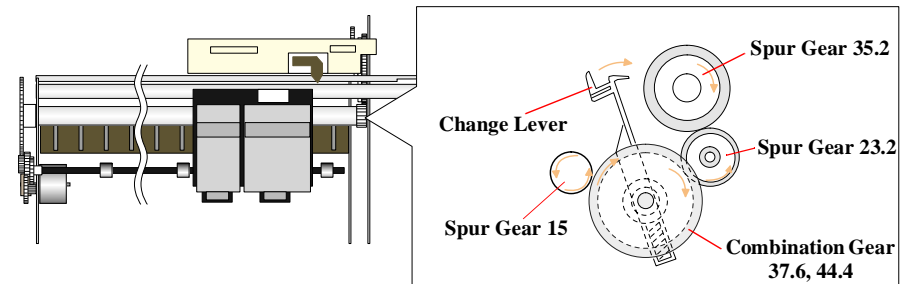

Figure 2-8. PF motor drive transmission path

When the PF motor torque is switched to the ASF unit side by the clutch mechanism, the function of the ASF mechanism varies depending on the rotational direction of the PF motor, as shown in the table below.

Table 2-3. ASF unit function & PF Motor rotational direction

Directions	Corresponding Functions
Clockwise (*1)	<ul style="list-style-type: none"> Picks up and loads paper
Counterclockwise (*1)	<ul style="list-style-type: none"> Release the DE lever & Clutch mechanism

(*1): The PF Motor rotational direction = seen from the right side of the printer.

□ Clutch Mechanism

Unlike the previous products, this product dose not have a ASF HP sensor. Instead of the ASF HP sensor, Change lever and the Clutch mechanism are used to detect the ASF home position. Following figures describe the mechanism.

NOTE:

The Clutch gear is molded on the back side of the Spur gear 35.2 such as Combination gear.

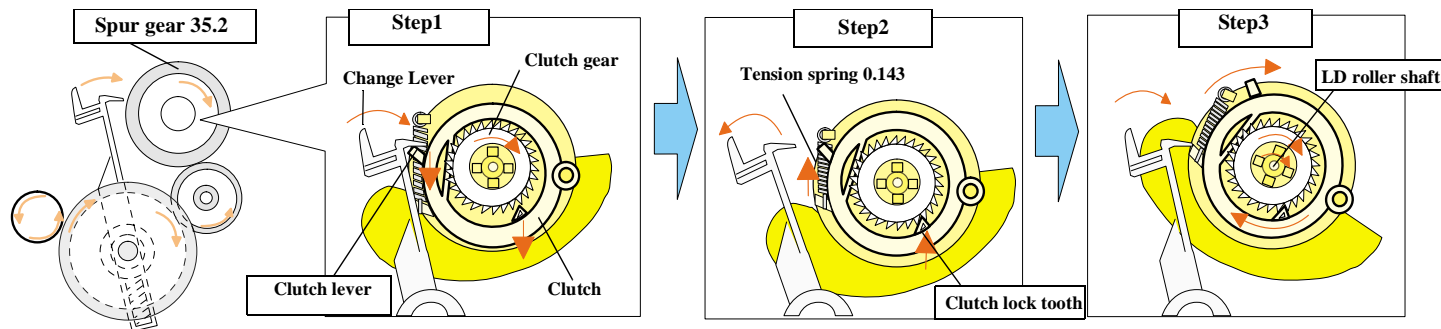

Figure 2-9. Disengage & Clutch mechanism

The Clutch mechanism transmits the PF motor drive to the LD roller shaft only when the Clutch gear rotates CW direction after the Change lever releases the Clutch lever. If the Clutch gear rotates CCW direction, the PF motor drive is not transmitted to the LD roller. This is due to the combination of the shape of the Clutch gear and the Clutch lock tooth such as described on the figure.

1. When the paper is advanced with the PF roller, the Change lever is set on the Clutch lever and the Clutch is pushed down as above Step1's figure. As the result, the Clutch gear (*1) is released from the Clutch lock tooth and the drive from the PF motor is not transmitted to the LD roller shaft.
2. When the PF pinion gear rotates CCW direction in the above Step2's figure, the Change lever moves to the left direction with the CCW rotation of Combination gear 37.6, 44.4. The Clutch turns back to the engagement position by the tension force of the Tension spring 0.143 and the Clutch gear is engaged with the Clutch lock tooth as above Step2's center figure.
3. When the PF pinion gear rotates CW direction in the above Step3's figure, the Change lever moves to the right direction with the CW rotation of the Combination gear 37.6, 44.4. And the drive from the PF motor is transmitted to the LD roller shaft via Clutch gear and Clutch lock tooth.
4. The LD roller shaft rotates about 360 degree and the Change lever push the Clutch lever and the PF motor drive is interrupted. This position is the ASF home position.

Paper Return Plate (Pad holder)

Unlike the previous products, The Paper return plate is built in the ASF frame instead of the Paper return lever. The Paper separation pad is also stacked on the plate. It works with the spring force of the Torsion spring 25.7 (mounted in the ASF frame) as following figure.

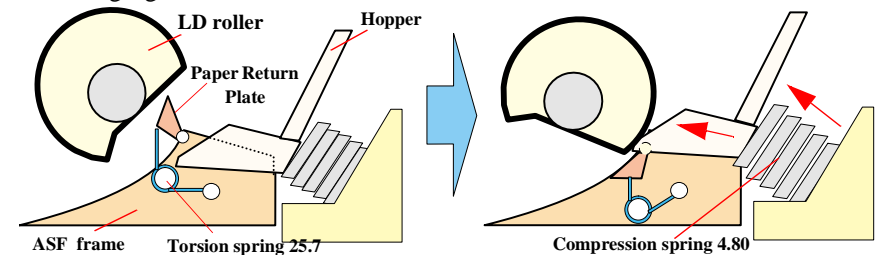

Figure 2-10. Paper Return Plate

The Paper return plate is set to return the paper to the paper stand-by position in the ASF unit when the ASF unit is in the standby mode. When the paper is fed with the LD roller, the Paper return plate is stored in the ASF frame by the LD roller.

Following figures show you the ASF paper loading sequence and the operation of the each mechanism.

When the paper is advanced with the PF roller, Change lever push down the Clutch lever as right figure and the Clutch lock tooth is disengaged from the Clutch gear. As the result, the drive from the PF motor is interrupted and the LD roller dose not rotate. This position is the ASF home position. The Paper return plate is set to avoid that the paper is slipped down from the paper set position.

The PF motor pinion gear rotates CW direction and the drive from the PF motor is transmitted to the ASF LD roller shaft through the Clutch lock tooth and the Clutch gear. The ASF hopper release lever rotates with the ASF LD roller and release the ASF Hopper. The ASF hopper is pushed with the Compression spring 4.80 and the paper is picked up with the ASF LD roller.

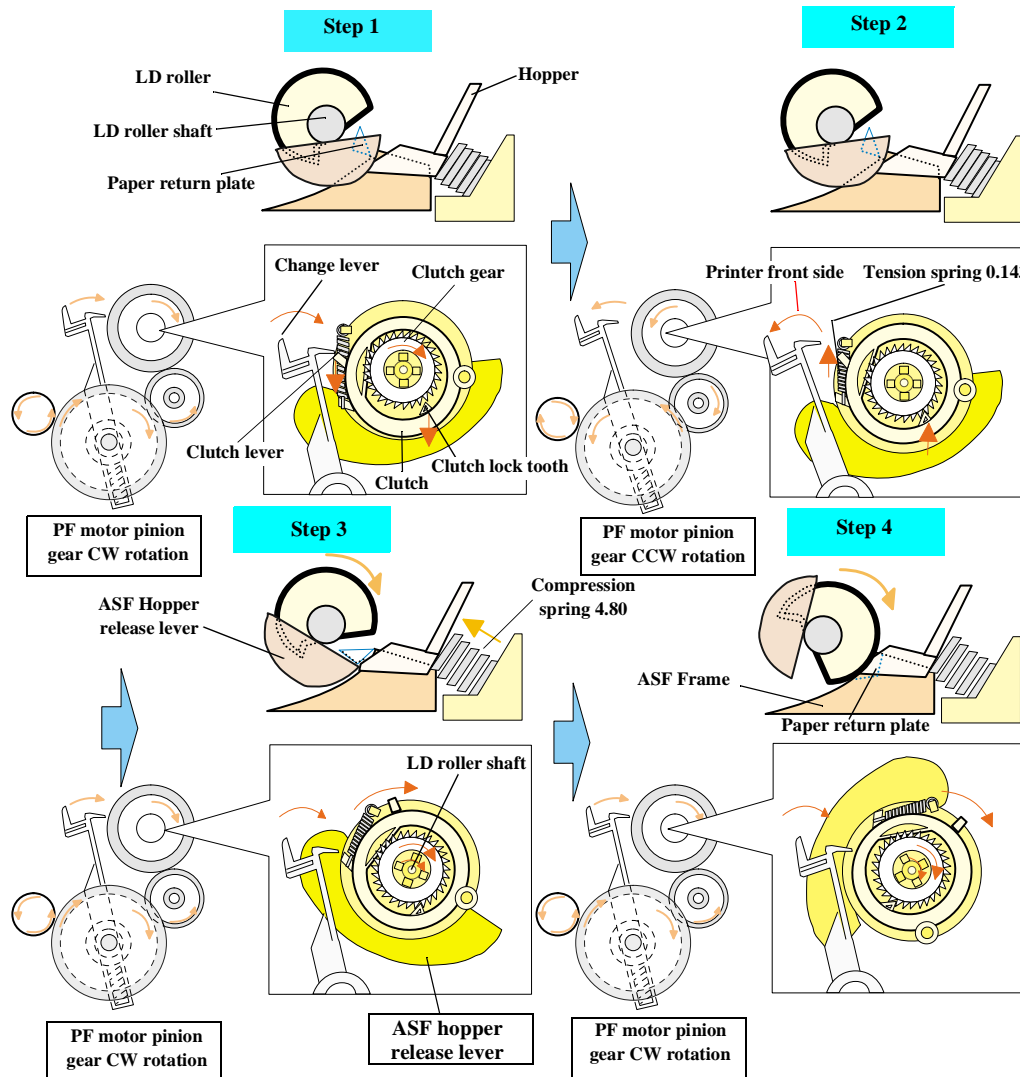

When the paper is loaded (pick up) from the ASF unit, the Change lever moves to the printer front side with the CCW rotation of the PF motor pinion gear and releases the Clutch lever. As the result, the Clutch turns back to the engagement position by the tension force of the Tension spring 0.143. And the Clutch lock tooth is engaged with the Clutch gear as right figure.

The ASF LD roller rotates CW direction moreover and the Paper return plate is stored under the ASF frame. The paper is advanced up to the PF roller, and the ASF LD roller & the clutch rotate to the "Step1" position. The Clutch lever is locked with the Change lever. The drive from the PF motor is interrupted and the drive is transmitted to the PF roller side.

Figure 2-11. ASF Paper Loading Sequence

2.1.6 Ink System Mechanism

Ink system mechanism consists of pump unit (include the CR lock lever) and capping mechanism. Ink system mechanism drives the pump unit that presses cap to the printhead and ejects ink from ink cartridge, head cavity and cap to the waste ink pad.

2.1.6.1 Pump Unit & Wiper mechanism

The pump unit is driven by PF motor. PF motor drive is always transmitted to the paper feeding mechanism and pump unit through the following gears. Refer to the Figure 2-13.

PF Motor Pinion Gear (CW) → Combination Gear 16, 21.6 (CCW) → Spur Gear 73.6 (CW) → Spur Gear 15 (CCW) → Combination Gear 37.6, 44.4 (CW) → Spur Gear 36.8 (CCW) → Combination Gear 9.6, 24 (CW) → Pump Unit Gear (CCW)

The Pump unit and Wiper mechanism drives according to the PF motor rotational direction, as shown in the right table.

Table 2-4. PF motor rotational direction & Ink System Mechanism

Directions	Functions
Counterclockwise (*1)	<ul style="list-style-type: none"> • Sets the wiper. • Absorbs ink by the pump unit • Set the CR lock lever
Clockwise (*1)	<ul style="list-style-type: none"> • Resets the wiper.

(*1): The PF Motor rotational direction = seen from the right side of the printer.

Following figure shows the overview of the pump mechanism operation.

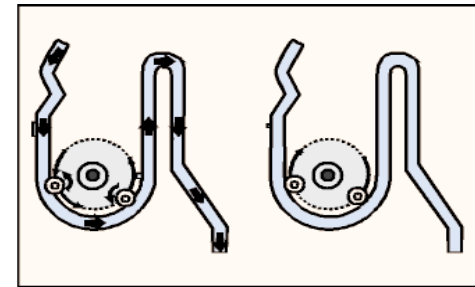

Figure 2-12. Pump mechanism

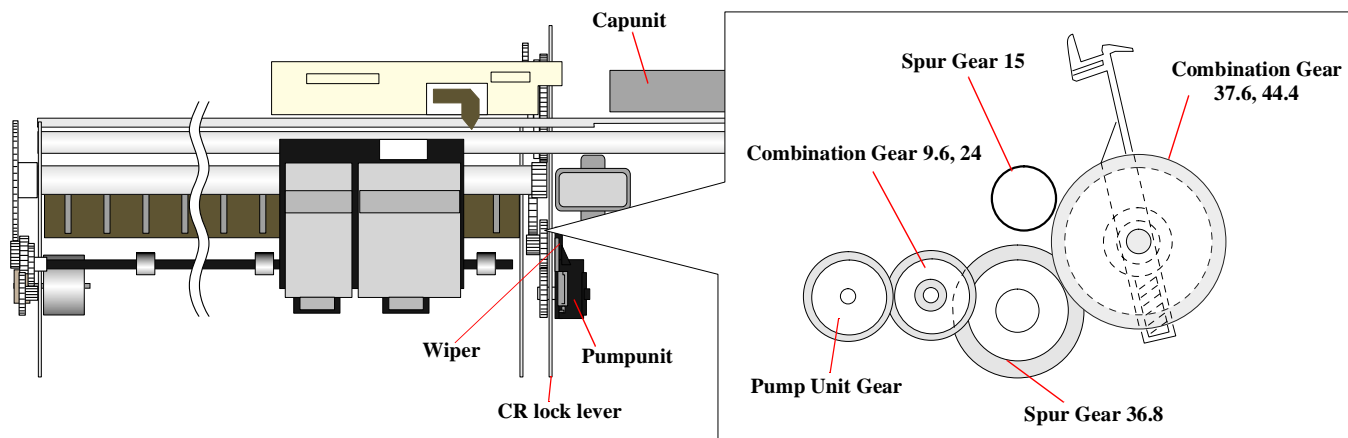

Figure 2-13. PF motor drive transmission path to the Pump unit

2.1.6.2 Capping Mechanism

The capping mechanism covers the printheads with the cap holder to prevent the nozzle from increasing viscosity when the printer is in stand-by mode or when the printer is off. This product has valveless cap system. Air valve function used for the previous models pumps and ejects ink only inside the cap by absorbing ink with the valve open. By opening the Air valve, the negative pressure is decreased and only the ink inside the cap is ejected. (the ink is not absorbed from Ink cartridge or head cavity.)

But, valveless cap system, this operation is done out side of the capping area.

The CR moves to left side of the Cap assembly and the pump absorbs the ink inside the cap.

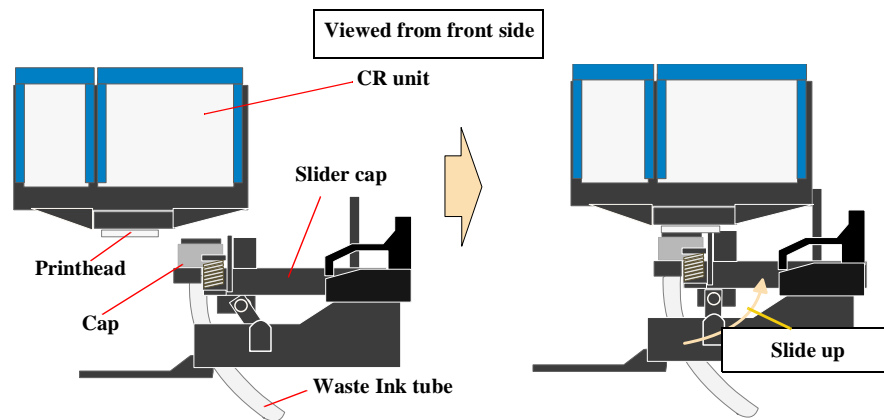

Figure 2-14. Cap Mechanism

2.2 Electrical Circuit Operating Principles

The electric circuit of the Stylus COLOR 680/777/777i consists of the following boards.

- Main board: C383 MAIN Board
- Power supply board: C383 PSB/PSE Board
- Panel board: C383 PNL Board

This section provides operating principles of C383 Board and C383 PSB/PSE Board. Refer to Figure 2-15 for the major connection of the each boards and their roles.

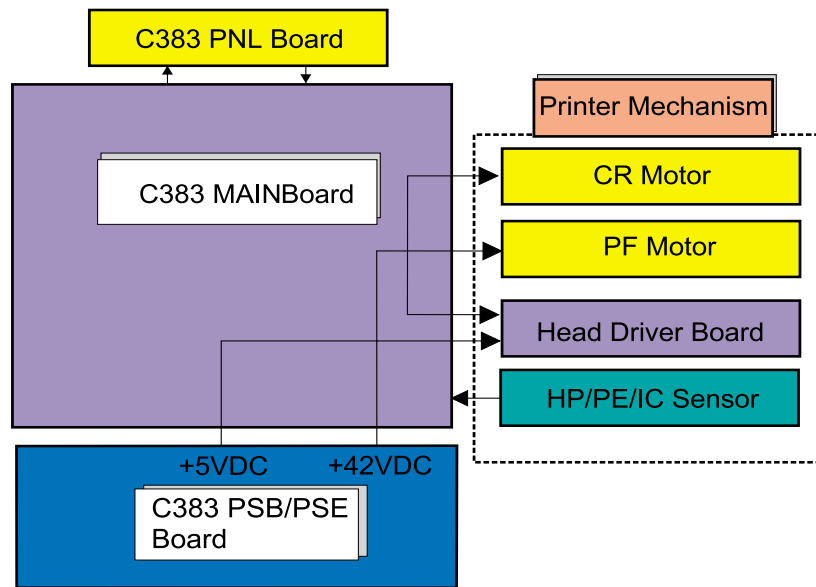

Figure 2-15. Electric Circuit

2.2.1 C383 PSB/PSE board

The power supply boards of Stylus COLOR 680/777/777i use a RCC (Ringing Chalk Converter) circuit, which generates +42VDC for drive line and +5VDC for logic line to drive the printer. The application of the output voltage is described below.

Table 2-5. Application of the DC Voltages

Voltage	Application
+42VDC	<ul style="list-style-type: none"> • Motors (CR Motor, PF Motor) • Printhead common voltage • Printhead nozzle selector 42V drive voltage
+5VDC	<ul style="list-style-type: none"> • C383MAIN control circuit logic • Sensor

AC voltage input from AC inlet first goes through filter circuit that removes high frequency components and is then converted to DC voltage via the rectifier circuit and the smoothing circuit. DC voltage is then lead to the switching circuit and FET Q1 preforms the switching operation. By the switching operation of the primary circuit, +42VDC is generated and stabilized at the secondary circuit. This +42VDC generated by the secondary circuit is converted to +5VDC by the chopping regulator IC of the secondary circuit.

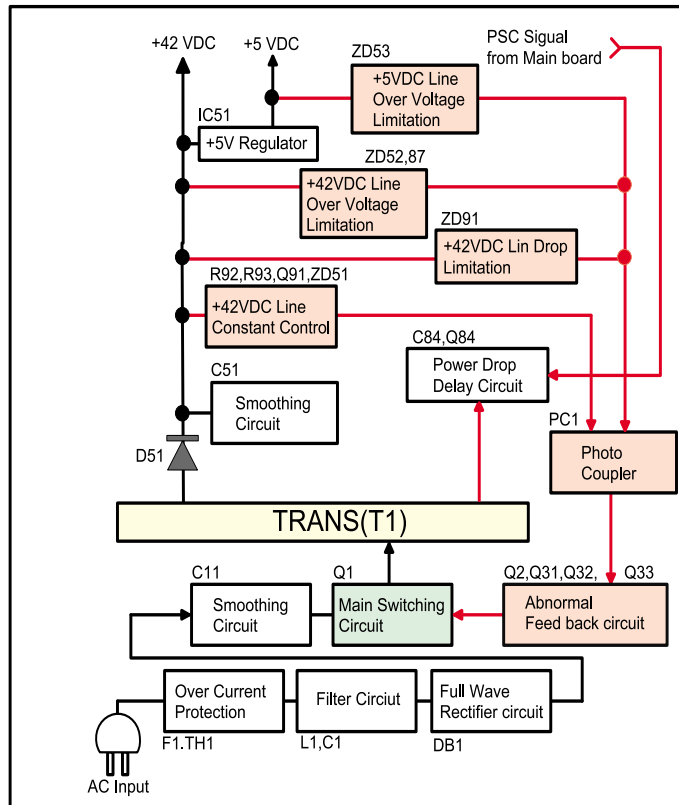

Figure 2-16. C383PSB/PSE Board Block Diagram

The C383 PSB/PSE board has the various control circuits to stop voltage output if a malfunction occurs on the power supply board or the main board while the printer mechanism is on duty. Following explains each control and protection circuit.

- Regardless of the state of the power switch (On or OFF), the voltage is always applied to the primary side of the power supply board from the moment or at the state that AC-plug is plugged in. At this time, F1 plays a role of preventing AC100V from coming into the F1. L1 also prevents high harmonic wave noise generated in the RC circuit filter which consists of C1 from going out, and eliminates the noise from outside here.
- The AC is full-wave rectified by the diode bridge DB1, and converted to $\sqrt{2} \times$ AC in voltage by the smoothing electrolytic capacitor C11.
- The pressured up direct current turns Q1 on through the starting resistor R31 and starts the primary side of the circuit.
- When the primary side is On, the energy (current) led by the electromagnetic induction through the trans (T1) does not flow to the secondary side since the diode (D51) on the secondary side is installed in the opposite direction.
- When the energy which is charged in the trans is reaching the saturated state, the voltage which makes Q1 on becomes weak gradually. At the point that this voltage drops at the certain voltage, C13 absorbs the current in the opposite direction and Q1 is quickly shut off by the resulting sharp drop.
- When the primary side is turned off, the energy charged in the T1 is opened according to the diode(D51) direction which is installed on the secondary side. Basically, 42 V DC is output by these circuit operations and the number of T1 spiral coil.
- +5VDC is generated by pressured down this +42VDC as power supply. IC51 pressures down the +42VDC and generates precise +5VDC by chopping off the output, forming the standard santooth wave form by the outer RC integration circuit.

The C383PSB/PSE board has the various control circuits to stop voltage output if a malfunction occurs on the power supply board or the main board or while the printer mechanism is on duty. Following explains each control and protection circuit.

- +42V Line Constant Voltage Control Circuit:
The output level of the +42V line is monitored by a detection circuit composed of the seven Zener diodes. This circuit prevents the voltage from dropping for a constant level of the output voltage.

- +5V line over voltage protection circuit:
This protection circuit is in the same line as the +42V over voltage protection circuit is located. The output voltage level of the +5V line is monitored by a Zener diode. This circuit shuts down the +5V line forcefully when the voltage level exceeds +9V.
- +42VDC line drop limitation circuit:
This protection circuit is in the same line as +42V over voltage protection circuit is located. The output voltage level of the +42V line is monitored by a Zener diode. This circuit shuts down the +42V line forcefully when the voltage level drops to +36V.
- +42VDC line over voltage circuit:
This circuit is in the same line as +5V line over voltage protection circuit is located. The output level is monitored by two Zener diodes. If the voltage level exceeds +48VDC, this circuit shuts down the +42V line forcefully.
- +5V line constant voltage/constant current control circuit:
The output current is monitored by the +5VDC generation switching control IC (IC51), which also monitors the output voltage. This information is input to the internal comparator and stabilizes +5V line. The operations of the secondary side switch are explained below.
 - When the power is turned on, Q1 repeats on/off automatically along with the increase and decrease of energy on the trans coil at the primary side. While the power is on, the PSC signal is input to the power supply board from the C383MAIN board.
 - This signal turns Q84 on and it becomes possible to discharge energy between the terminals 8 and 9 of T1. At this time, even if the power is turned off, the electrolytic capacitor keeps Q84 on for a while, and by this electrolytic capacitor, voltage output is held at least 30 seconds. This time helps the printer to complete a power-off operation.

2.2.2 C383 MAIN Board

The printer mechanism is controlled by C383 MAIN. See Figure for the C383 MAIN board block diagram.

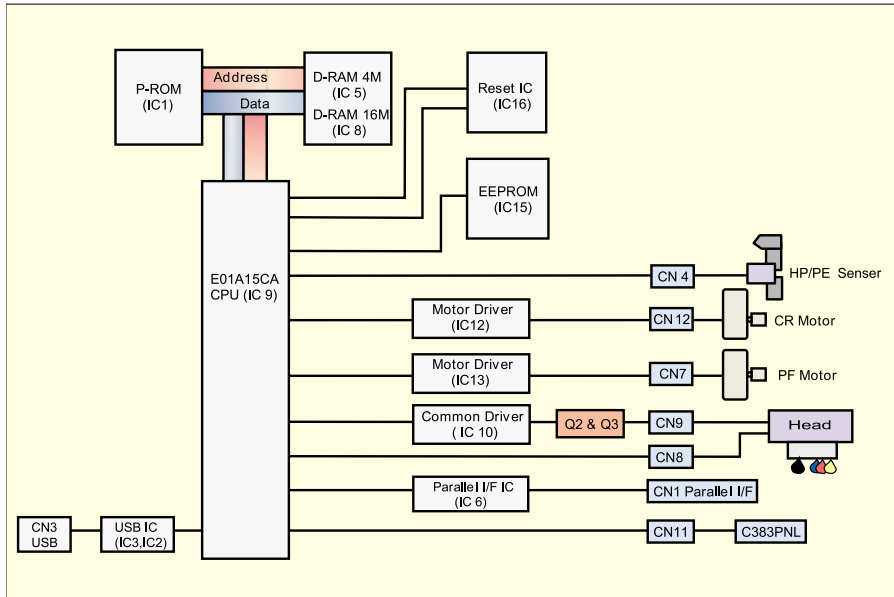

Figure 2-17. Block Diagram for the C383 MAIN Board

Following shows you the major characteristic of this main board.

- Use of the 3.3V chips in the logic circuit
The 3.3 V regulator (IC11) on the C383MAIN produces 3.3 V by pressuring down the 5.5 VDC, also generated on this board, to drive several chips. See the table below that separately shows the chips driven by the +5V and +3V.

Table 2-6. 3.3V Drive Chips & 5.5V Drive Chips

+5V	3.3V
Sensors	CPU
I/F Circuit	P-ROM
PNL Board	D-RAM

- Timer IC & Lithium battery are not mounted
Unlike the previous products, the Timer IC and the Lithium battery are not mounted on the Main board. So, this product perform the Power-on cleaning or Timer cleaning based on the time command which is sent from the printer driver.
- D-RAM
4Mbit and 16Mbit D-RAMS are mounted on the Main board.
- One CPU controls the all function on the main board.

2.2.2.1 Main elements

Table 2-7 shows the function of the each main elements on C383 MAIN.

Table 2-7. Main Elements

IC	Location	Function
CPU E01A15CA	IC9	16bit CPU mounted on the MAIN board is driven by clock frequency 24MHz and controls the printer.
PROM	IC1	<ul style="list-style-type: none"> Capacity 8/16/32/64MB, Bus= 16 bit Program for CPU
RAM	IC5, IC8	Bus= 16 bit, 4Mbit DRAM and 16Mbit DRAM
EEPROM	IC15	1kbit EEPROM <ul style="list-style-type: none"> Default value setting Parameter backup
Reset IC	IC16	Reset IC <ul style="list-style-type: none"> For +5V; reset when +4.2V is detected For +42V, reset when +33.2 is detected
Common Driver	IC10	Head drive control HIC <ul style="list-style-type: none"> Generates head common voltage.
Motor Driver	IC12	CR motor drive IC
Motor Driver	IC13	PF motor drive IC
Parallel I/F IC	IC6	IEEE1284 parallel I/F transceiver IC.
USB IC	IC2, IC3	USB transceiver IC

2.2.2.2 Printhead Driver Circuit

The printhead driver circuit consists of the following two components:

- Common driver IC (IC10:E09A14RA) directly attached to the C383MAIN board.
- Nozzle selector IC on the head board.

The common driver (IC10:E09A14RA) generates a reference drive waveform according to the output signals from the C383MAIN board. The reference drive waveform is amplified by the transistors Q2 and Q3 and then transferred to the nozzle selector IC on the head board. Print data is converted to serial data by the CPU (IC9) and then sent to the nozzle selector IC on the head board. Based on the serial data, the nozzle selector IC determines the nozzles to be actuated. The selected nozzles are driven by the drive waveforms produced by the common driver. See Figure 2-18 for the printhead driver circuit block diagram.

Head common driver circuit

The reference head drive waveform is produced in the common driver (IC10:E09A14RA) based on the following 12 signal lines output from the ASIC (IC8 E05B70CD); A0-A4, CLK1, CLK2, RST, FLOOR, DATA, DCLK, and E. By the DATA signal output from the CPU (IC9), the original data for the head drive waveform is written in the memory in the IC10. The addresses for the written data are determined by the A0 - A4 signals, and, of among, data used to determine the waveform angles is selected. Then, setting the selected data, producing trapezoid waveform value, and canceling the data are performed by the rising edges of the CLK1 and CLK2 signals.

Head nozzle selector circuit

Printing data is converted into serial data by the CPU (IC9). Then the converted data is allocated to the six rows, the number of the head nozzle rows, to be transferred to the nozzle selector through the six signal lines (HS01 to HS06). Data transmission from the CPU (IC9) to the nozzle selector synchronizes with the LAT signal and SCK clock signal. Referring to the transferred data, nozzles to be activated are selected, and the PZTs of the selected nozzles are driven by the drive waveform output from the head common driver.

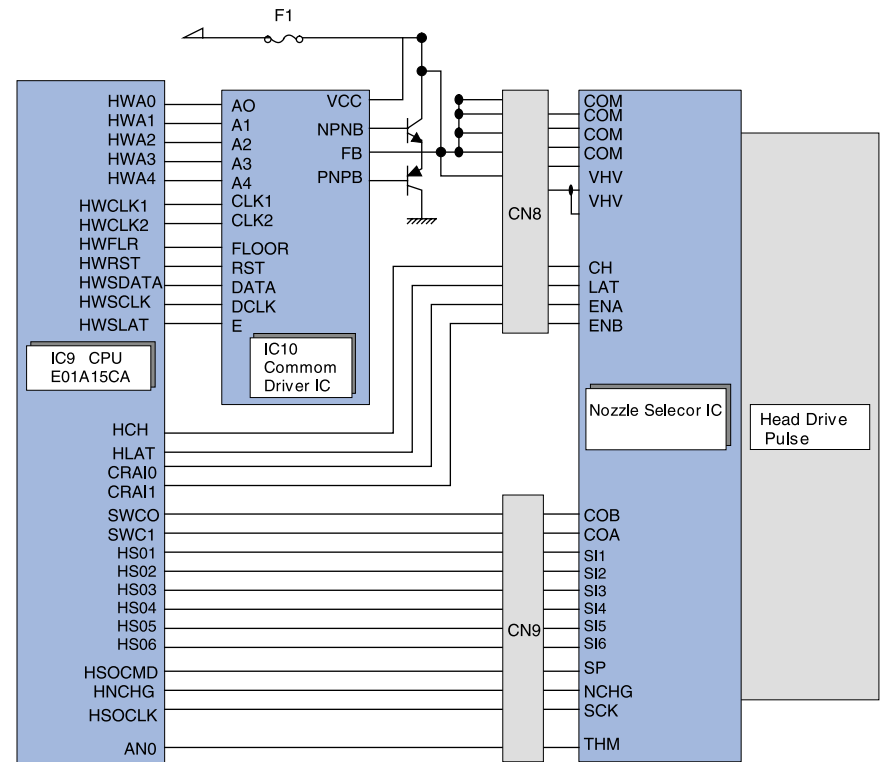

Figure 2-18. Printhead Driver Circuit

2.2.2.3 PF Motor (PF/ PUMP/ ASF Motor) Driver Circuit

The motor driver IC (IC13) on the MAIN board drives PF motor. This product uses 4-phase 200-pole hybrid type stepping motor and performs constant current bi-polar drive.

CPU (IC9) converts PF motor phase control signal to LB11847 micro step drive form and outputs to motor driver IC (IC13) LB11847 from port 101, 112. Based on this signal, IC13 determines the phase mode.

The current value on each phase is determined by CPU (IC9) and outputs from port 104, 105, 107, 108, 109, 110 to driver IC (IC13). Motor driver IC generates motor driver waveform based on these input signals and controls the motor. If the printer dose not receive any data from PC for 5 minutes, CPU set the motor drive current to 0 via port 104, 105, 107, 108, 109, 110 and the motor drive is turned off to save the power consumption.

2.2.2.4 CR Motor Driver Circuit

The motor driver IC (IC12) on the MAIN board drives PF motor. This product uses 4-phase 200-pole hybrid type stepping motor and performs constant current bi-polar drive.

CPU (IC9) converts PF motor phase control signal to LB11847 micro step drive form and outputs to motor driver IC (IC12) LB11847 from port 81, 94. Based on this signal, IC12 determines the phase mode.

The current value on each phase is determined by CPU (IC9) and outputs from port 83, 84, 85, 86, 87, 88, 90, 91 to driver IC (IC12). Motor driver IC generates motor driver waveform based on these input signals and controls the motor. If the printer dose not receive any data from PC for 5 minutes, CPU set the motor drive current to 0 via port 83, 84, 85, 86, 87, 88, 90, 91 and the motor drive is turned off to save the power consumption.

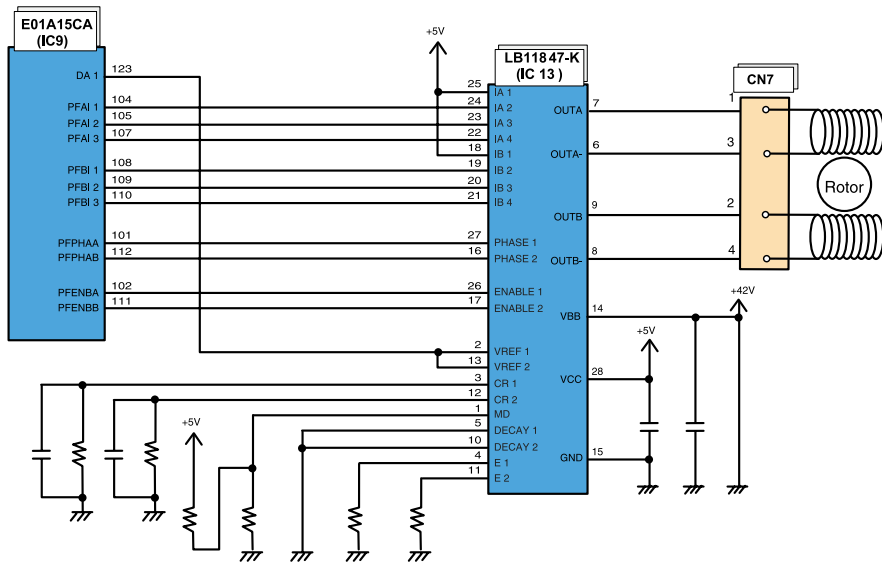

Figure 2-19. PF Motor Driver Circuit Block Diagram

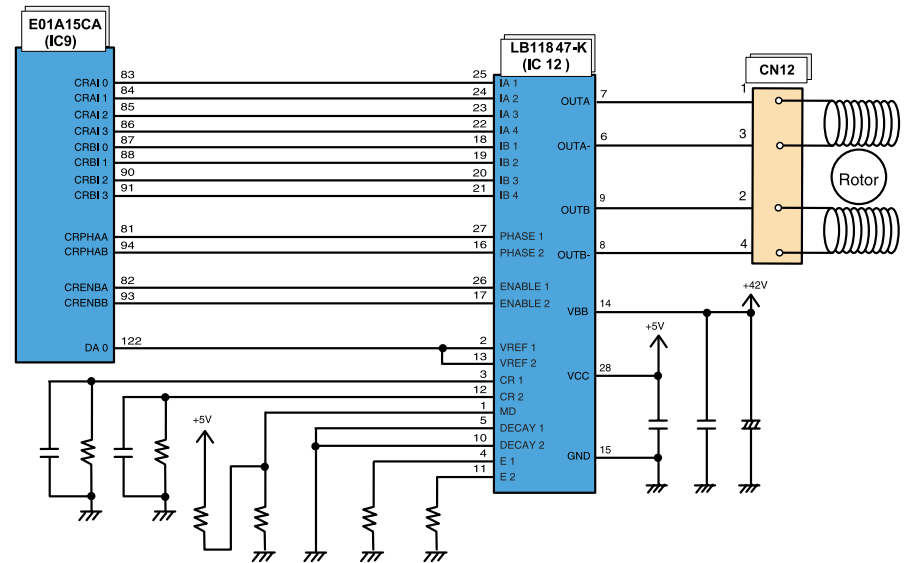

Figure 2-20. CR Motor Driver Circuit Block Diagram

2.2.2.5 Reset Circuit

Reset circuits consist of the rest IC (IC16). Reset circuits are mounted on the MAIN board to monitor the two voltages: +5V for the logic line and +42V for the drive line. When each circuit detects abnormality on the corresponding line, it outputs a reset signal to reset CPU (IC9). This function is necessary to prevent the printer from operating abnormally. This IC monitors both +5V and +45 lines but can reset them independently. The reset circuits outputs reset signal when +5V line becomes 4.2V or lower or +42V line becomes 33.2V or lower.

Unlike the previous products, the timer IC is not built in the reset IC and the Lithium battery also is not equipped on the main board.

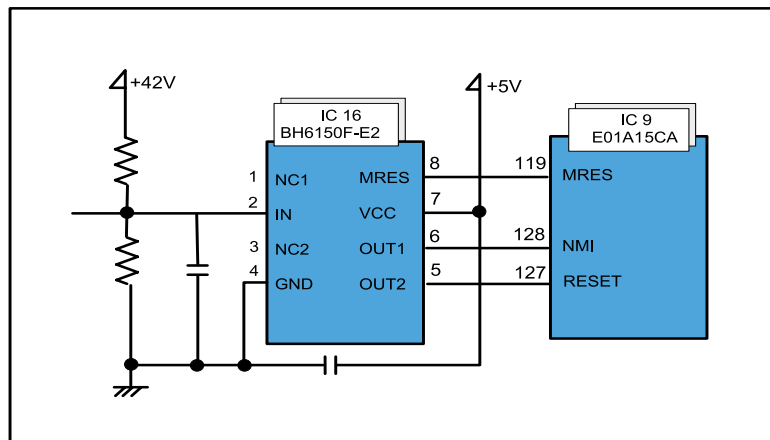

Figure 2-21. Reset Circuit Block Diagram

Main signal lines are explained below;

- OUT1: Interrupt signal
- OUT2: Reset line
- IN: +42V line monitoring line
- VCC: +5V line monitoring line

2.2.2.6 EEPROM Control Circuit

Since EEPROM is nonvolatile memory, it keeps written information if the printer power is turned off. When the printer is turned ON, CPU (IC9) reads data from EEPROM (IC15) and when the power is turned OFF it stores data to EEPROM.

Information stored in EEPROM is listed below.

- Various ink counter (I/C consumption counter, waste pad counter, etc.)
- Mechanical setting value (Head ID, Bi-D adjustment, USB ID, etc.)

See Table 7-9, “EEPROM Address Map,” on page 127 that provides detailed information on the values stored in EEPROM.

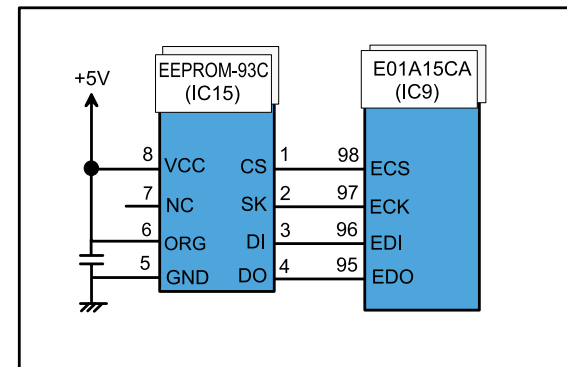

Figure 2-22. EEPROM Circuit Diagram

EEPROM is connected to CPU with 4 lines and each line has the following function.

- CS: Chip selection signal
- CK: Data synchronism clock pulse
- DI: Data writing line (serial data) at power off.
- DO: Data reading line (serial data) at power on.

2.2.2.7 Sensor Circuit

C383 MAIN is equipped with the following two sensors to detect the status of the printer. Unlike the previous product, ASF HP sensor is not equipped on the ASF and the ASF HP is determined with the clutch mechanism (2.1.4 Paper Feeding Mechanism).

□ **HP/PE Sensor**

This sensor uses photo interrupter method and detects the following three status. The photo interrupt component and two detection levers consists of this sensor.

■ **CR home position**

The CR home position is detected on the right edge of the CR shaft with the HP/PE sensor during the power on sequence. In case the CR home position is detected in the power on sequence, this sensor outputs HIGH signal to the CPU.

When the LOW signal is output to the CPU in the detection position, the CR unit is out of home position.

■ **Paper Top & End position**

When the Paper is in the paper path, this sensor outputs the HIGH signal. When the Paper is not in the paper path, this sensor outputs the LOW signal. This status is always monitored during the printer is in the power on status with this sensor.

□ **Thermistor (THM)**

The thermistor is attached directly on the printhead driver board. It monitors the temperature around the printhead and determines the proper head drive voltage according to the ink viscosity that varies by the temperature. This information is fed back to the CPU analog port. When the temperature rises, the head drive circuit lowers the drive voltage. When the temperature lowers, the head drive circuit rises the drive voltage.

The block diagram for the sensor circuit is shown below

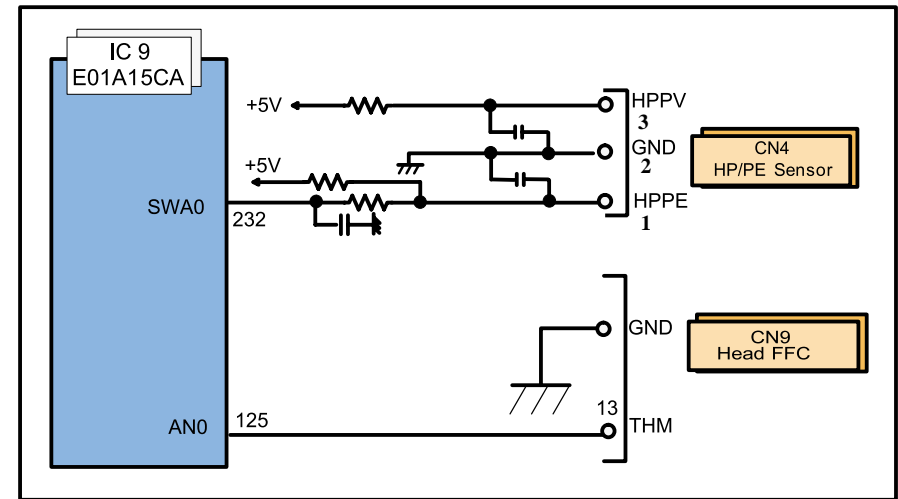

Figure 2-23. Sensor Circuit Diagram

CHAPTER

3

TROUBLESHOOTING

3.1 Overview

This chapter describes how to identify troubles in two levels: unit level repair and component level repair. Refer to the flowchart in this chapter to identify the defective unit and perform component level repair if necessary. This chapter also explains motor coil resistance, sensor specification and error indication.

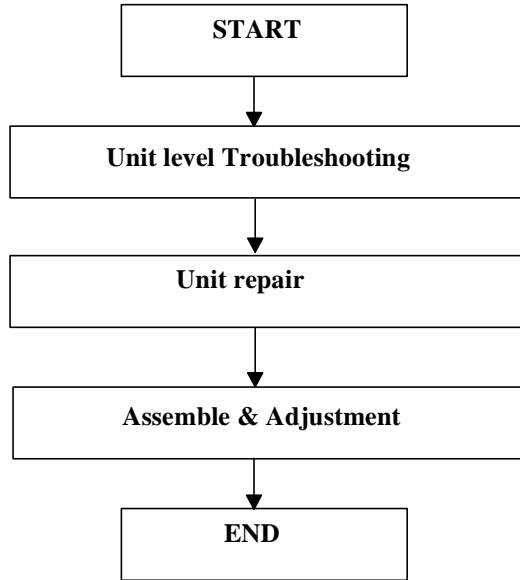

Figure 3-1. Troubleshooting Flowchart

Table 3-1. Motor, Coil Resistance

Motor	Location	Check Point	Resistance
CR Motor	CN12	Pin 1 and 3 Pin 2 and 4	7.8 Ohms ± 10% (at 25 °C/ phase)
PF Motor	CN7	Pin 1 and 3 Pin 2 and 4	7.8 Ohms ±10% (at 25 °C/ phase)

Table 3-2. Sensor Check Point

Sensor Name	Check Point	Signal Level	Switch Mode
HP/PE Sensor	CN4/Pin 1 and 2	Less than 0.7V	Off <ul style="list-style-type: none"> • Out of HP range • No paper • Detect the I/C
		More than 2.4V	On <ul style="list-style-type: none"> • Within HP range • Detect the paper • Not detects the I/C
Thermistor (THM)	TH1 (on the Head driver board)	Analog signal	10 K (at 24 °C)

3.2 Troubleshooting with LED Error Indications

This section describes how to troubleshoot the problem when the printer indicates an error at power on and can not print. The Stylus COLOR 680/777/777i can detect the following six errors and seven status, and indicates them with the LEDs, as shows below.

Table 3-3. Error Indicator of Operation Panel

Printer Status	Indicators		Priority
	Power	Error	
Power ON condition	On	-	10
Ink sequence	Blink	-	6
Ink Cartridge change mode	Blink	-	5
Data processing	Blink	-	9
Paper Out	-	On	4
Paper jam condition	-	On	3
Ink end (Black)	-	On -> Blink	8
Ink level low (Black)	-	Blink	8
Ink end (Color)	-	On -> Blink2	8
Ink level low (Color)	-	Blink	8
Ink end (Black and Color)	-	Blink -> Blink	8
No Ink Cartridge (Black and Color)	-	On	7
Maintenance request (Ink Overflow Counter error)	Alt Blink	Alt Blink	2
Fatal error	Off	On	1

" - " : Indicator status don't change.

" A -> B " : A is a indicator condition when carriage is on Home Position.

B is a indicator condition in Ink exchange sequence.

See the following tables which show the error conditions and corresponding possible causes:

Table 3-4. Error Condition and possible cause

Symptom	Possible Cause	Check table
Paper out error indication (Paper is not loaded correctly)	<ul style="list-style-type: none"> The friction of the LD roller is lowered due to the paper dust. The clutch mechanism is broken. Tension spring 0.143 come off in the clutch mechanism. Compression spring 0.98 comes off. Tip of Change lever has any damage. PF motor is broken. 	Table 3-5 Table 3-6 Table 3-7
Paper jam error indication	<ul style="list-style-type: none"> Star wheel assembly is not assembled on the Paper eject frame. The Spur gear 15 is not assembled correctly. The paper guide front is not assembled correctly or has any damage. The PE detection lever dose not move smoothly. 	Table 3-8 Table 3-9 Table 3-10
No I/C or Ink Out error indication	<ul style="list-style-type: none"> 	
Multiple papers are always loaded	<ul style="list-style-type: none"> The paper return plate dose not work correctly. 	Table 3-12
Paper is always loaded without any print job	<ul style="list-style-type: none"> The Change lever is broken in the Clutch mechanism. 	Table 3-13
Fatal error indication	<ul style="list-style-type: none"> HP sensor lever or PE sensor lever dose not move smoothly. HP/PE sensor is defective. CR motor is defective. PF motor is defective. Main board is defective. Printer Housing dose not secured with screw on -the printer mechanism. 	Table 3-14 Table 3-15 Table 3-16

Table 3-4. Error Condition and possible cause (continued)

Symptom	Possible Cause	Check table
Any error indication is not displayed. But, the paper is not ejected completely. Paper jam dose not occur.	<ul style="list-style-type: none"> Paper eject roller gear is disengaged from the pump's gears. The Paper eject frame is not assembled in the Paper eject frame. 	Figure 3-17
Dot missing occur and it is not recovered with CL	<ul style="list-style-type: none"> Pump unit dose not absorb the ink from the printhead. Cap unit dose not stick on the surface of the printhead completely. The printhead is broken. The head FFC has any damage. The main board is defective. 	Figure 3-18 Figure 3-19 Figure 3-20
Print quality is not good <ul style="list-style-type: none"> Vertical banding Horizontal banding Printing is blurred Ink stains the paper 	<ul style="list-style-type: none"> The accuracy of the CR motor is lowered. The lack of the lubricant around the CR unit. The both I/C is not held in the CR unit securely. The Paper eject frame is deformed. Any foreign material is sticking around the printhead. Paper feed accuracy is lowered. Printer driver setting is not suitable. Paper path has ink stain somewhere. 	Table 3-21 Table 3-22 Table 3-23

If the problem fits to the detail phenomenon in the table, make sure the check point and repair the product following the corresponding remedy mentioned in the table when you find the defective parts in the check point.

Table 3-5. Paper out error indication

Step No.	Detail phenomenon	Check point	Remedy
1	ASF LD roller attempt to load the paper. But, paper is not loaded at all. The LD roller seems slipping.	<ul style="list-style-type: none"> Check the surface of the LD roller if the micro pearl or severe smear is adhered.  <p>If it is no problem, proceed the next step.</p>	<ul style="list-style-type: none"> Set a cleaning sheet in the ASF up side down. Then holding the top edge, try to load the paper from the Printer driver. The micro pearl on the LD roller surface is removed. To remove severe smear, staple a cloth moistened with alcohol to a post card and clean the roller in the same manner.  <ul style="list-style-type: none"> If the problem is not solved, replace the LD roller with new one.

Table 3-6. Paper out error indication

Step No.	Detail phenomenon	Check point	Remedy
2	ASF LD roller dose not attempt to load the paper. But, the PF motor and the Spur gear 35.2 is rotating. 	<ul style="list-style-type: none"> Check if the clutch tooth is broken.  <p>If it is no problem, proceed the next step.</p>	<ul style="list-style-type: none"> Replace the clutch mechanism with new one.
3	ASF LD roller dose not attempt to load the paper. But, the PF motor and the Spur gear 35.2 is rotating.	<ol style="list-style-type: none"> Check if the tension spring 0.143 comes off in the Clutch mechanism.  	<ol style="list-style-type: none"> Se the tension spring 0.143 in the clutch mechanism. Set the Compression spring 1.47 in the Change lever.

Table 3-7. Paper out error indication

Step No.	Detail phenomenon	Check point	Remedy
4	When the print data is sent to the printer, ASF LD roller continue to load the paper even if the first paper is loaded to the PF roller and the paper is ejected while the ASF hopper is flapping.	<ol style="list-style-type: none"> Check if the tip of the Change lever has any damage.  Check if the Compression spring 1.47 comes off from the Change lever.  <p>If it is no problem, proceed the next step.</p>	<ol style="list-style-type: none"> Replace the Change lever with new one. Set the Compression spring 1.47 in the Change lever.
5	When the printer is turned on, ASF hopper dose not operate at all in the power on sequence.	<ol style="list-style-type: none"> Check if the PF motor connector is connected to the CN7. Check if the PF motor coil resistance is about 7.8 ohm by using tester Refer to Table 3-1. 	<ol style="list-style-type: none"> Connect the PF motor connector to the CN7 on the Main board. Replace the PF motor with new one. If the problem is not solved, replace the Main board with new one.

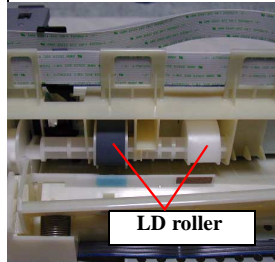
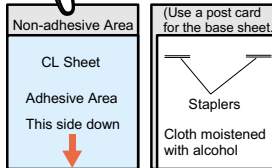
Table 3-8. Paper jam error indication

Step No.	Detail phenomenon	Check point	Remedy
1	Paper is not ejected completely and jammed around the Paper eject frame.	<ul style="list-style-type: none"> Check if the star wheel assembly is assembled in the Paper eject frame.  <p>If it is no problem, proceed the next step.</p>	<ul style="list-style-type: none"> Remove the jammed paper and assemble the Star wheel assembly in the Paper eject frame completely. <p>If the hook portion of the Star wheel assembly is broken, replace the Star wheel assembly with new one.</p>
2	Ditto	<ul style="list-style-type: none"> Check if the Paper eject roller is rotating correctly.  <p>If it is no problem, proceed the next step.</p>	<ul style="list-style-type: none"> Set the tip of the Spur gear 25.6 to the Combination gear 11.6, 36.8 and assemble it correctly.

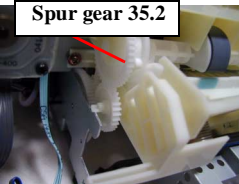
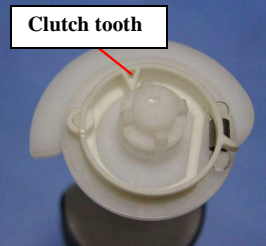
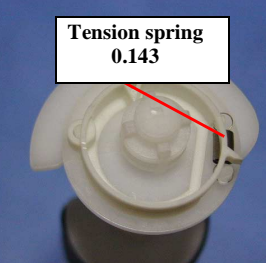
Table 3-9. Paper jam error indication

Step No.	Detail phenomenon	Check point	Remedy
3	The paper is jammed around the Front paper guide.	<ol style="list-style-type: none"> Check if the Front paper guide is floating from the assemble position. Check if there is any damage around the rear edge of the each rib on the Front paper guide.  <p>If it is no problem, proceed the next step.</p>  <p>Front Paper guide</p>	<ol style="list-style-type: none"> Assemble the Front paper guide front to the suitable portion and confirm the PF grounding spring is securing the Front paper guide. Replace the Front paper guide with new one.
4	Paper is loaded correctly from ASF. But, after complete the print job, paper jam indicated on the screen without any paper jam. If you send the new print job in this condition, the General error is indicated on the screen.	<ul style="list-style-type: none"> Check if the Torsion spring 0.22 comes off on the both PE sensor lever.  <p>PE sensor lever</p>	<ul style="list-style-type: none"> If the Torsion spring 0.22 is not set on the correct position, set it correctly. If any paper dust is placed around the PE sensor lever, remove it. If it is no problem, proceed the next step.

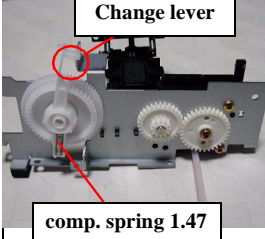
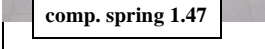
Table 3-10. Paper jam error indication

Step No.	Detail phenomenon	Check point	Remedy
5	When the paper is loaded from the ASF and ejected without any printing. After eject the paper, paper eject sequence is continued. If any print job is sent to the printer, General error is displayed.	<ol style="list-style-type: none"> 1. Check if the CN4 connector cable for HP/PE sensor cable is disconnected on the Main board or sensor. 2. Check if the HP/PE sensor operates correctly by using the tester. Refer to Table 3-2. 	<ol style="list-style-type: none"> 1. Connect the CN4 connector cable to the CN4 on the Main board. 2. Replace the HP/PE sensor with new one. 3. If the problem is not solved, replace the Main board with new one.

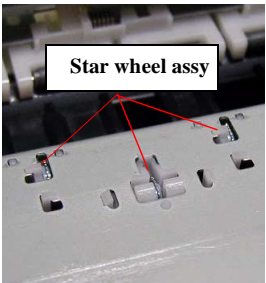
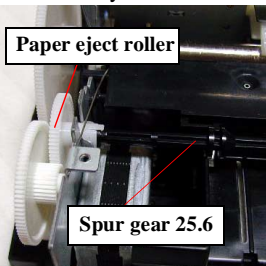
Table 3-11. No Ink Cartridge or Ink Out error indication

Step No.	Detail phenomenon	Check point	Remedy
1	A [No Ink Cartridge] or [Ink Out Error] message is displayed when the power to the printer is switched on.	<ol style="list-style-type: none"> 1. Check to ascertain that an ink cartridge has been set in place. 2. Check the remaining ink with the printer driver or STM3. 3. Check to ascertain that the head FFC is been attached correctly to the head. 4. Check to ascertain that the head FFC has been attached correctly to the main board. 	<ol style="list-style-type: none"> 1. Set the ink cartridge in place. 2. Remove and then reset the ink cartridge in place. 3. Replace the ink cartridge (faulty CSIC.) 4. Replace the ink cartridge (faulty CSIC.)

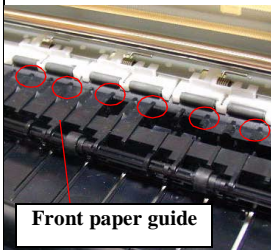
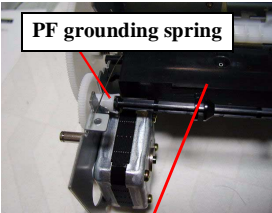
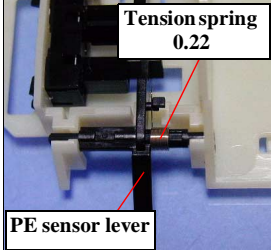
Table 3-12. Multiple papers are always loaded

Step No.	Detail phenomenon	Check point	Remedy
1	Any error indication is not displayed on the monitor. But, multiple papers are always loaded from ASF.	Check if the Paper return plate is operating correctly in the ASF when the paper is loaded.	<ul style="list-style-type: none"> • Assemble the torsion spring 25.7 in the ASF frame. 

Table 3-13. Paper is always loaded without any print job

Step No.	Detail phenomenon	Check point	Remedy
1	Paper is always loaded from ASF without any print job. ASF hopper continue to flapping when the printer is turned on.	<ol style="list-style-type: none"> 1. Check if the tip of the Change lever has any damage.  <ol style="list-style-type: none"> 2. Check if the Compression spring 1.47 comes off from the Change lever. 	<ol style="list-style-type: none"> 1. Replace the Change lever with new one. 2. Set the Compression spring 1.47 in the Change lever.

Table 3-14. Fatal Error indication

Step No.	Detail phenomenon	Check point	Remedy
1	When the printer is turned on, the printer continue the paper eject sequence even if the paper is not in the paper path.	1. Check if the Torsion spring 0.22 comes off on the both HP sensor lever.	1. Set the Torsion spring 0.22 on the HP sensor lever.
			
		2. Check if the Torsion spring 0.22 comes off on the both PE sensor lever.	2. Set the Torsion spring 0.22 on the PE sensor lever.
			
		3. Check if the CN4 connector cable is connected on the CN4 on the Main board or sensor.	3. Connect the CN4 connector cable to the CN4 on the Main board.
		4. Check if the HP/PE sensor work correctly by using the tester. Refer to Table 3-2.	4. Replace the HP/PE sensor with new one.
			5. If the problem is not solved, replace the Main board with new one.

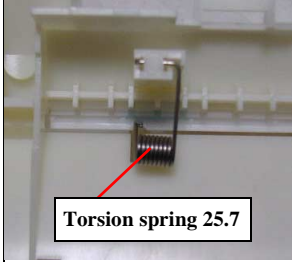
Table 3-15. Fastal Error indication

Step No.	Detail phenomenon	Check point	Remedy
2	When the printer is turned on, the CR unit dose not move at all in the power on sequence.	1. Check if the CR motor connector is connected CN12 on the Main board.	1. Connect the CR motor connector to the CN12 on the Main board.
		2. Check if the coil resistance of the CR motor is about 7.8ohm by using the tester. Refer to Table 3-1.	2. Replace the CR motor with new one.
3	When the printer is turned on, PF roller dose not rotate at all in the power on sequence.		3. If the problem is not solved, replace the Main board with new one.
		1. Check if the PF motor connector is connected to the CN7.	1. Connect the PF motor connector to the CN7 on the Main board.
		2. Check if the PF motor coil resistance is about 7.8 ohm by using tester.	2. Replace the PF motor with new one.
			3. If the problem is not solved, replace the Main board with new one.

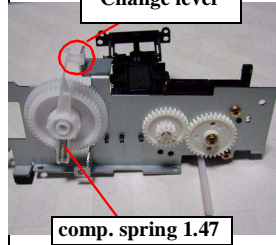
Table 3-16. Fatal Error indication

Step No.	Detail phenomenon	Check point	Remedy
4	When the printer is turned on, it sounds strange noise and the CR unit is stopped around the CR lock lever.	<ol style="list-style-type: none"> 1. Check if the Top housing is secured with the fixing screw at the front side.  <ol style="list-style-type: none"> 2. Check if the Change lever is placed to the printer front side.  <ol style="list-style-type: none"> 3. Check if the PF motor is operated. Check the CN7 connector and the coil resistance for PF motor. 4. If the CR lock lever is not released even if the PF motor rotate in the power on sequence, check if one of the gears has any damage in the PF motor torque transportation path. Refer to Figure 2-13. 	<ol style="list-style-type: none"> 1. Secure the Housing fixing screw at the printer front side. 2. Turn back the Change lever to the printer back side with the tweezers or small screw driver. 3. Connect the PF motor cable to CN7 on the Main board. Replace the PF motor with new one. 4. Change the damaged gear with new one. 5. If the problem is not solved, replace the Main board with new one.

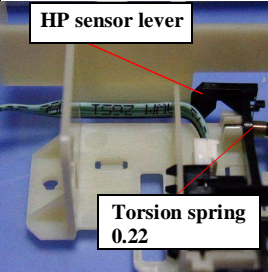
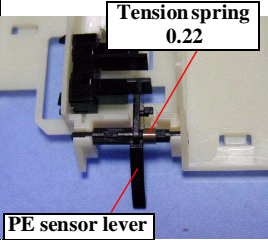
Table 3-17. Paper is not ejected completely without any error indication

Step No.	Detail phenomenon	Check point	Remedy
1	Printing is normal. But, the paper is not ejected completely and the bottom area stay around the Paper eject frame.	<ol style="list-style-type: none"> 1. Check if the Paper eject roller rotate when the paper is ejected. 2. Check if the Paper eject frame is secured with the three fixing screws to the Main frame. 	<ol style="list-style-type: none"> 1. Assemble the Spur gear 25.6 to the Combination gear 11.6, 36.8. 2. Secure the Paper eject frame with the two fixing screws to the Main frame. 

Table 3-18. Dot missing occur and it is not recovered with CL

Step No.	Detail phenomenon	Check point	Remedy
1	In the CL sequence, the pump unit seems work correctly. But, ink is not ejected to the waste ink pad at all. Moreover, any ink is not absorbed from the head to the cap.	<ol style="list-style-type: none"> 1. Check if ink is ejected to the waste ink pad via pump unit in the CL sequence. 2. Check if there is any foreign material around the seal rubber parts on the cap assembly.  <p>Cap seal rubber parts</p> <ol style="list-style-type: none"> 3. Check if any damage is observed around the seal rubber parts on the cap assembly. 4. Check if the two compression spring are assembled in the Cap assembly correctly.  <p>Compression spring</p>	<ol style="list-style-type: none"> 1. If ink is not ejected at all to the waste ink pad in the CL sequence, proceed the following check point 2). 2. Remove the foreign material around the seal rubber parts. 3. Replace the Cap assembly with new one. 4. Set the Compression spring into the Cap assembly.

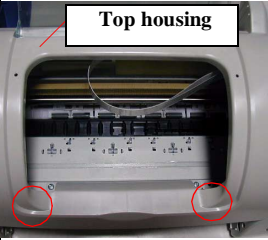
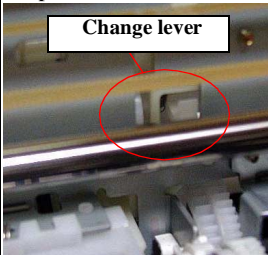
Table 3-19. Dot missing occur and it is not recovered with CL

Step No.	Detail phenomenon	Check point	Remedy
1	In the CL sequence, the pump unit seems work correctly. But, any ink is not ejected to waste ink pad. Moreover, any ink is not absorbed from the head to the cap.	<ol style="list-style-type: none"> 5. Check if the Pump tube is connected to the bottom of the Cap assembly correctly.  <p>Pump tube connection point</p> <ol style="list-style-type: none"> 6. Check if the pump tube has a little slack between the Cap assembly and the pump unit when the Cap assembly is slide up completely.  <p>Tube Cap assy. Pump unit</p>	<ol style="list-style-type: none"> 7. Connect the Pump tube to the bottom of the Cap assembly deeply. 8. Pump unit may coil the pump tube inside the unit. In this case, pull out the coiled tube from the pump unit carefully. After that, connect the pump tube to the Cap assembly after placing the tube correctly. 9. If the problem is not solved, replace the Pump unit with new one.

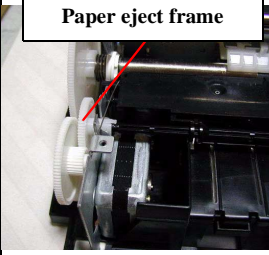
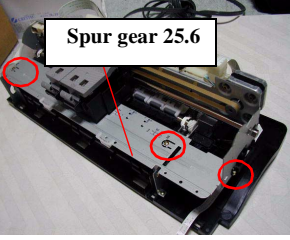
Table 3-20. Dot missing occur and it is not recovered with CL

Step No.	Detail phenomenon	Check point	Remedy
2	In the CL sequence, ink is ejected to the Waste ink pad (this means pump unit & cap unit are working correctly). But, the dot missing is not solved at the specific nozzles even if the several CLs are performed.	<ol style="list-style-type: none"> 1. Check if the segment in the nozzle check patten is reduced every CL & Nozzle check pattern printing. 2. Check if any damage is observed on the Head FFC. 	<ol style="list-style-type: none"> 1. Replace the I/C with new one in the I/C replacement sequence. 2. Replace the Head FFC with the new one. 3. Replace the printhead with new one.
3	In the CL sequence, ink is ejected to the Waste ink pad. But, dot missing is occurred on all nozzle in the printing and is not solved in the several CLs.	<ol style="list-style-type: none"> 1. Check if the Head FFC is connected to the CN8 and CN9 on the Main board or Head FFC. 	<ol style="list-style-type: none"> 1. Connect the Head FFC securely to the CN8 and CN9 on the Main board or Printhead. 2. Replace the Printhead with new one. 3. Replace the Main board with new one.

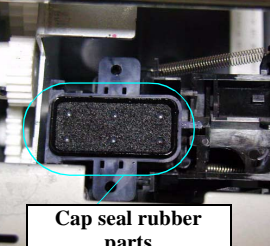
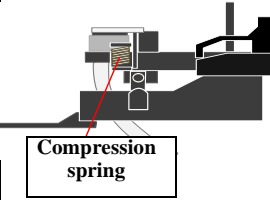
Table 3-21. Print quality is not good

Step No.	Detail phenomenon	Check point	Remedy
1	<p>Vertical banding is appeared against the CR movement direction. And it looks like uneven printing.</p> 	<ol style="list-style-type: none"> 1. Check if each segment is printed correctly in the nozzle check pattern. 2. Check if the surface of the CR guide shaft dose not have any sever stain. 3. Check if the surface of the CR sliding portion on the Paper eject frame has enough oil. 	<ol style="list-style-type: none"> 1. Perform the CL and check the nozzle check pattern. 2. Clean the surface of the CR guide shaft with the dry soft cloth and lubricate G-55 inside the CR guide shaft. 3. Clean the surface of the CR sliding portion on the Paper eject frame and lubricate specific amount of the G-26. 4. Reassemble the CR guide shaft into the mounting slat on the both side frame and secure it with Rod spring. 5. Replace the CR guide shaft with new one. 6. Replace the Paper eject frame with new one.
		<ol style="list-style-type: none"> 4. Check if the CR guide shaft is assembled in the correct portion securely. 5. Check if the surface of the CR guide shaft is flat. 6. Check if the surface of the Paper eject frame is flat. 	

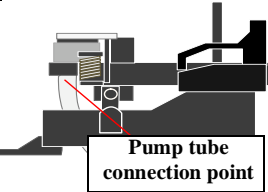
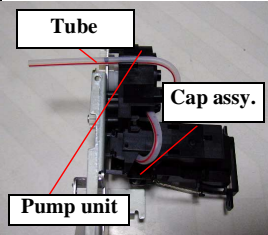
Table 3-22. Print quality is not good

Step No.	Detail phenomenon	Check point	Remedy
1	Ditto		7. Replace the following parts. <ul style="list-style-type: none"> • CR motor • CR timing belt • Compression spring 19.6
2	Micro banding appears horizontally against the paper feeding direction and it appears with the same width. 	1. Check if each segment is printed correctly in the nozzle check pattern. 2. Check if the suitable paper is used according to the printer driver setting. 3. Check if the Paper feed roller is dirty. 4. Check if the following parts do not have any damage. <ul style="list-style-type: none"> • Combination gear 16, 21.6 • Combination gear 11.6, 36.8 • Spur gear 73.6 • Spur gear 25.6 	1. Perform the CL and check the nozzle check pattern. by using the Adjustment program. 2. Use the suitable paper according to the printer driver setting. 3. Clean the surface of the PF roller carefully with the soft brush 4. Replace the damaged parts with new one. 5. Replace the Printhead with new one.

Table 3-23. Print quality is not good

Step No.	Detail phenomenon	Check point	Remedy
3	Printing is blurred	1. Check if the suitable paper is used according to the printer driver setting. 2. Check if the correct head ID is stored in the EEPROM by using the Adjustment program.	1. Use the suitable paper according to the driver setting. 2. Input 6 digits code of the head ID into the EEPROM by using the Adjustment program.
4	Ink stains the paper	1. Check if the following parts are stained with ink. <ul style="list-style-type: none"> • Upper paper driven roller • PF roller • Paper guide front • Paper eject roller. 2. Check if there is some ink drops around the backside of the printhead. 3. If the bottom area of the printed paper has ink stain, check if the Paper eject frame is secured with three screws. 4. If the bottom area of the printed paper has ink stain, check if the Paper eject frame is bent upward.	1. Clean the ink stained parts with soft cloth. 2. Wipe off the ink drop with the soft cloth carefully. 3. Secure the screws fixing the Paper eject frame. 4. Replace the Paper eject frame with new one.

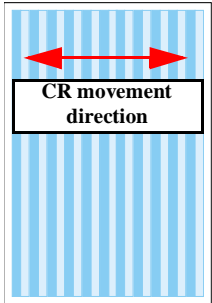
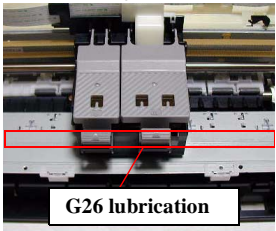
CHAPTER

4

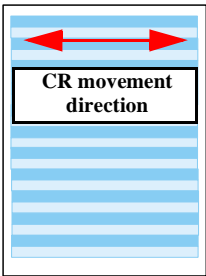
DISASSEMBLY AND ASSEMBLY

4.1 Overview

This section describes procedures for disassembling the main components of the Stylus COLOR 680/777/777i. Unless otherwise specified, disassembly units or components can be reassembled by reversing the disassembly procedure. Things, if not strictly observed, that could result in injury or loss of life are described under the heading “Warning”. Precautions for any disassembly or assembly procedures are described under the heading “CAUTION”. Chips for disassembling procedures are described under the heading “CHECK POINT”.

If the assembling procedure is different from the reversed procedure of the disassembling, the procedure is described under the heading “REASSEMBLY”.

Any adjustments required after disassembling the units are described under the heading “ADJUSTMENT REQUIRED”. When you have to remove any units or parts that are not described in this chapter, refer to the exploded diagrams in the appendix.

Read precautions described in the next section before starting.

4.1.1 Precautions

See the precautions given under the handling “WARNING” and “CAUTION” in the following column when disassembling or assembling EPSON Stylus COLOR 680/777/777i.



- **Disconnect the power cable before disassembling or assembling the printer.**
- **Wear protective goggles to protect your eyes from ink. If ink gets in your eye, flush the eye with fresh water and see a doctor immediately.**
- **Always wear gloves for disassembly and reassembly.**
- **If ink comes into contact with your skin, wash it off with soap and water. If irritation occurs, contact a physician.**
- **A lithium battery is installed on the main board of this printer. Be sure to observe the following instructions when serving the battery:**
 1. Keep the battery away from any metal or other batteries so that electrodes of the opposite polarity do not come in contact with each other.
 2. Do not heat the battery or put it near fire.
 3. Do not solder on any part of the battery. (Doing so may result in leakage of electrolyte from the battery, burning or explosion. The leakage may affect other devices close to the battery.)
 4. Do not charge the battery. (An explosion may be generated inside the battery, and cause burning or explosion.)
 5. Do not dismantle the battery. (The gas inside the battery may hurt your throat. Leakage, burning or explosion may also be resulted.)
 6. Do not install the battery in the wrong direction. (This may cause burning or explosion.)
- **Danger of explosion if the battery is incorrectly replaced. Replace only with the same or equivalent type recommended by the manufacture. Dispose the used batteries according to government’s law and regulations.**
- **Wear gloves when disassembly and reassembly to protect sharp metal edges.**

CAUTION

Risque d'explosion si la pile est remplacée incorrectement. Ne remplacer que par une pile du même type ou d'un type équivalent recommandé par le fabricant. Eliminer les piles déchargées selon les lois et les règles de sécurité en vigueur.

CAUTION

- Never remove the ink cartridge from the carriage unless this manual specifies to do so.
- When transporting the printer after installing the ink cartridge, be sure to pack the printer for transportation without removing the ink cartridge.
- Use only recommended tools for disassembling, assembling or adjusting the printer.
- Apply lubricants and adhesives as specified. (See Chapter 6 for details.)
- Make the specified adjustments when you disassemble the printer. (See Chapter 5 for details.)
- When assembling, if an ink cartridge is removed and needs to be installed again, be sure to install a new ink cartridge because of the following reasons;
 1. Once the ink cartridge mounted on the printer is removed, air comes in and creates bubbles in the cartridge. These bubbles clog ink path and cause printing malfunction.
 2. If an ink cartridge in use is removed and is reinstalled, ink quantity will not be detected correctly since the counter to check ink consumption is cleared.
- Because of the reasons above, make sure to return the printer to the user with a new ink cartridge installed.

4.1.2 Tools

Use only specified tools to avoid damaging the printer.

Name	Supplier	Parts No.
Phillips Screw Driver (No.1)	EPSON	B743800100
Phillips Screw Driver (No.2)	EPSON	B743800200
Nipper	EPSON	B740500100
Tweezers	EPSON	B741000100

4.1.3 Work Completion Check

If any service is made to the printer, use the checklist shown below to confirm all works are completed properly and the printer is ready to be returned to the user.

Table 4-1. Work Completion Check

Classification	Item	Check Point	Status	
Main Unit	Self-test	Is the operation normal?	<input type="checkbox"/> Checked <input type="checkbox"/> Not necessary	
	On-line Test	Is the printing successful?	<input type="checkbox"/> Checked <input type="checkbox"/> Not necessary	
	Printhead	Is ink discharged normally from all the nozzles?	<input type="checkbox"/> Checked <input type="checkbox"/> Not necessary	
	Carriage Mechanism		Does it move smoothly?	<input type="checkbox"/> Checked <input type="checkbox"/> Not necessary
			Is there any abnormal noise during its operation?	<input type="checkbox"/> Checked <input type="checkbox"/> Not necessary
			Is there any dirt or foreign objects on the CR Guide Shaft?	<input type="checkbox"/> Checked <input type="checkbox"/> Not necessary
			Is the CR Motor at the correct temperature? (Not too heated?)	<input type="checkbox"/> Checked <input type="checkbox"/> Not necessary
	Paper Feeding Mechanism		Is paper advanced smoothly? • No paper jamming? • No paper skew? • No multiple feeding? • No abnormal noise?	<input type="checkbox"/> Checked <input type="checkbox"/> Not necessary
			Is the PF Motor at correct temperature?	<input type="checkbox"/> Checked <input type="checkbox"/> Not necessary
			Is the paper path free of any obstructions?	<input type="checkbox"/> Checked <input type="checkbox"/> Not necessary
	Adjustment	Specified Adjustment	Are all the adjustment done correctly?	<input type="checkbox"/> Checked <input type="checkbox"/> Not necessary

Table 4-1. Work Completion Check (continued)

Classification	Item	Check Point	Status
Lubrication	Specified Lubrication	Are all the lubrication made at the specified points?	<input type="checkbox"/> Checked <input type="checkbox"/> Not necessary
		Is the amount of lubrication correct?	<input type="checkbox"/> Checked <input type="checkbox"/> Not necessary
Function	ROM Version	Version:	<input type="checkbox"/> Checked <input type="checkbox"/> Not necessary
Packing	Ink Cartridge	Are the ink cartridges installed correctly?	<input type="checkbox"/> Checked <input type="checkbox"/> Not necessary
	Protective Materials	Have all relevant protective materials been attached to the printer?	<input type="checkbox"/> Checked <input type="checkbox"/> Not necessary
Others	Attachments, Accessories	Have all the relevant items been included in the package?	<input type="checkbox"/> Checked <input type="checkbox"/> Not necessary

4.2 Disassembly

The flowchart below shows step-by-step disassembly procedures. When disassembling each unit, refer to the page number shown in the figure.

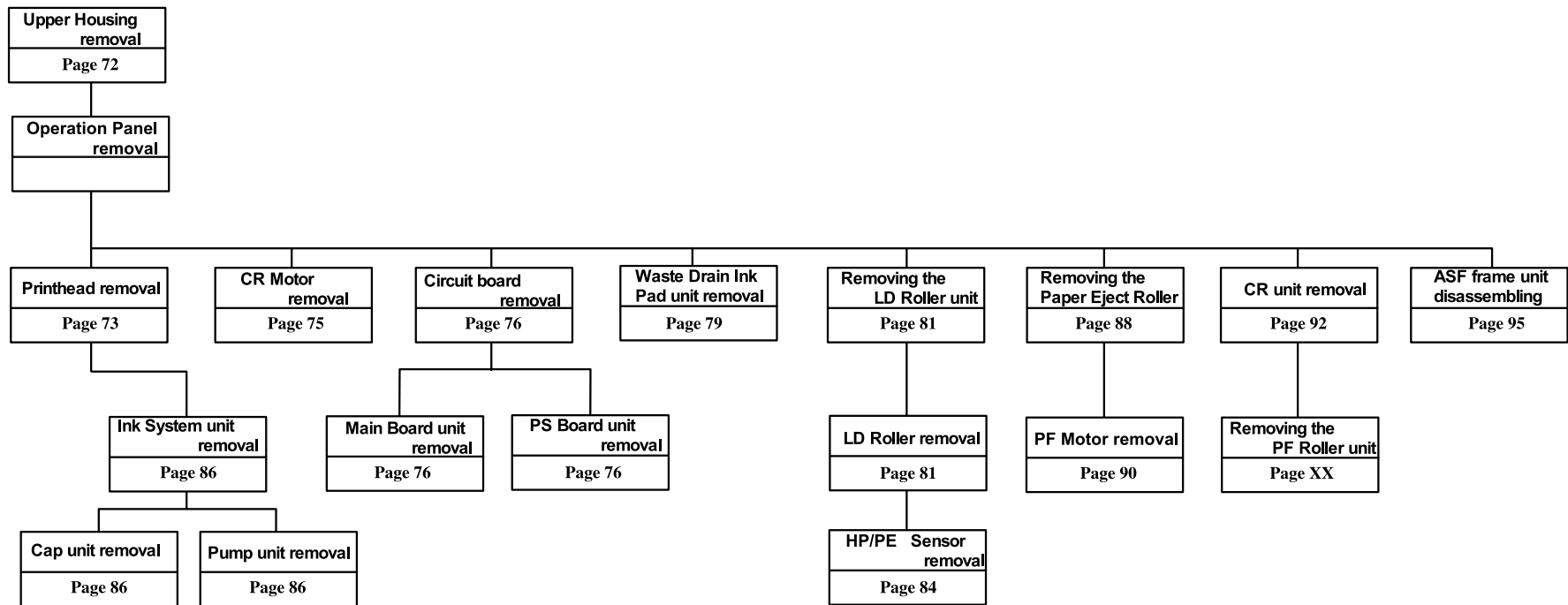

Figure 4-1. Disassembling Flowchart

4.2.1 Housing removal

1. Open the printer cover and remove 2 screws (C.B.S-TITE R 3x6 F/Uc) at the printer front side.

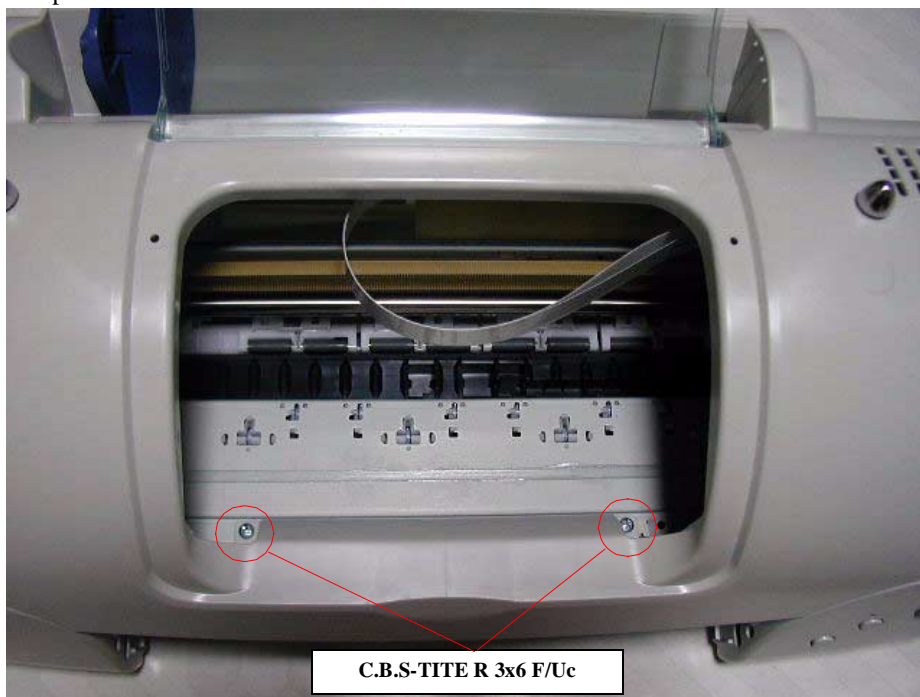

Figure 4-2. Removing 2 screws for Housing

2. Remove 2 screws (C.B.S. 3x6 F/Zn) at the back of the printer and remove the Housing.

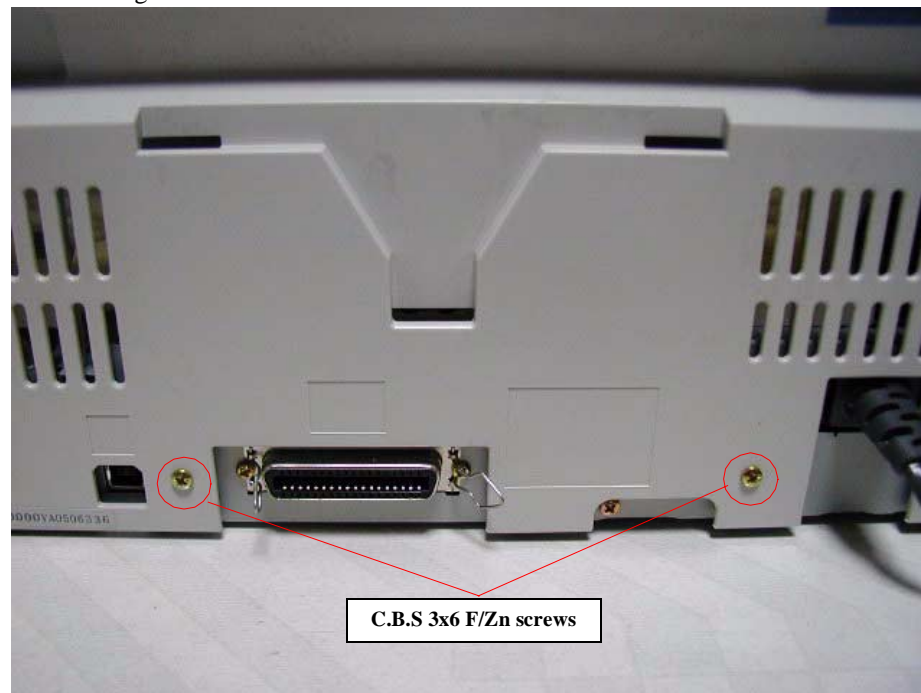

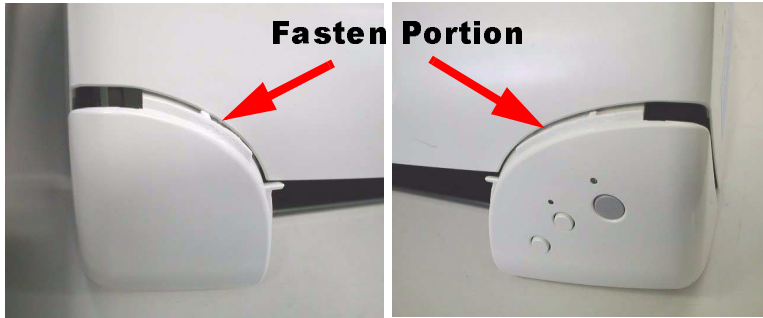



Figure 4-3. Removing 2 screws for Housing

3. Remove the Upper Housing from the Left and Right Panel as well as the Mechanism.

<p>CAUTION</p> 	<p>When removing the Upper Housing from the left and right Panel, don't broke these parts since they were fastened slightly with glue. (Refer to following pictures.)</p>
	

<p>REASSEMBLY</p> 	<p>■ Tightening Torque for screw</p> <ul style="list-style-type: none"> • C.B.S-TITE R3x6 F/Uc screw for housing front side: 6 +/- 1kgf.cm • C.B.S 3x6 F/Zn screw for housing back side : 6+/- 1kgf.cm <p>■ It is not necessary to glue the Upper Housing to the Left and Right Panel.</p>
<p>CAUTION</p> 	<p>■ Ensure that C.B.S-TITE 3 x 6 F/Uc screws are used for the two screws on the front side of the printer. The tips of these screws are rounded for user's safty.</p>

4.2.2 Operation Panel removal

The panel board equipped with printer is as follows:

- Stylus COLOR 680: C383PNL

1. Remove the Housing from the printer. (Refer to Section 4.2.1.)
2. Remove 2 screws (C.B.S 3x6 F/Zn) securing the Operation Panel Assembly. Then, disconnect the Operation Panel Assembly from the Printer Mechanism.

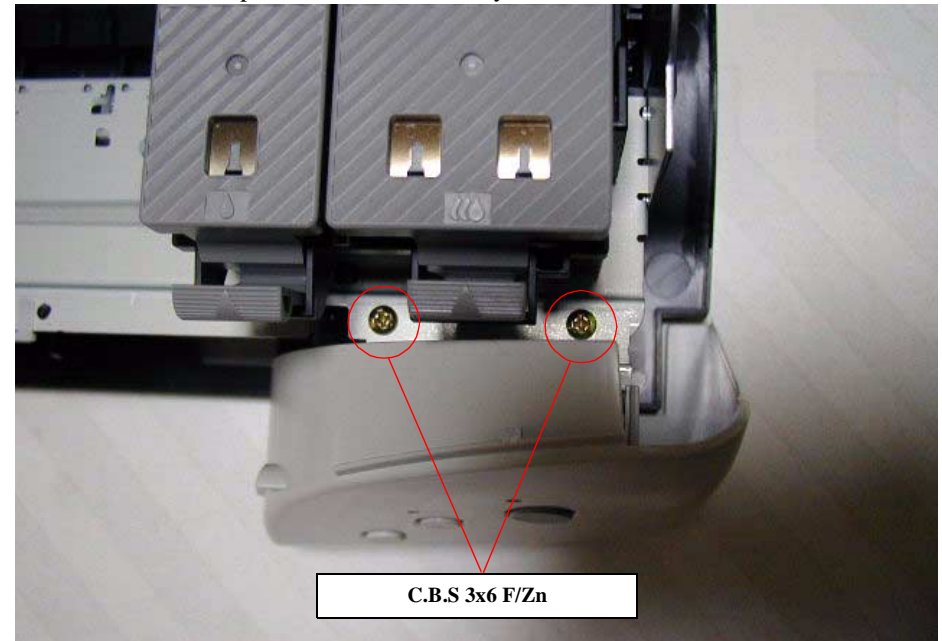

Figure 4-4. Removing 2 screws for Operation Panel

- Remove 2 screws (C.B.P-TITE 3x8 F/Zn) and detach the Sub Right Panel Housing from the Operation Panel Assembly.

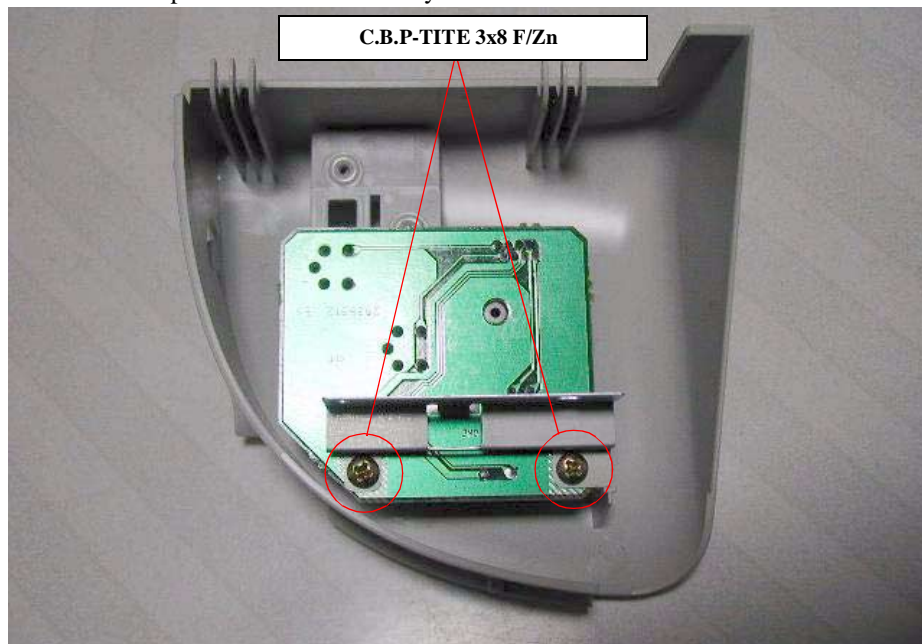

Figure 4-5. Removing 2 screws for C383PNL board

- Remove the Panel Shield Plate and the C383PNL board from the Operation Panel Assembly.
- Disconnect the Panel FFC from the connector on the C383PNL board.



■ Removing the Operation Panel Assembly also separates the stacker assembly from the Printer Mechanism, since the Stacker Assembly is held with Operation Panel.

4.2.3 Printhead removal

- Remove the Housing from the printer. (Refer to Section 4.2.1.)
- Open the Cover Cartridge and remove the both black and color ink cartridge.
- Remove the Cover Cartridges for black and color ink cartridges from the CR Assembly.
- Remove the Head FFC Holder from the CR Assembly by releasing two hooks. Refer to Figure 4-x.

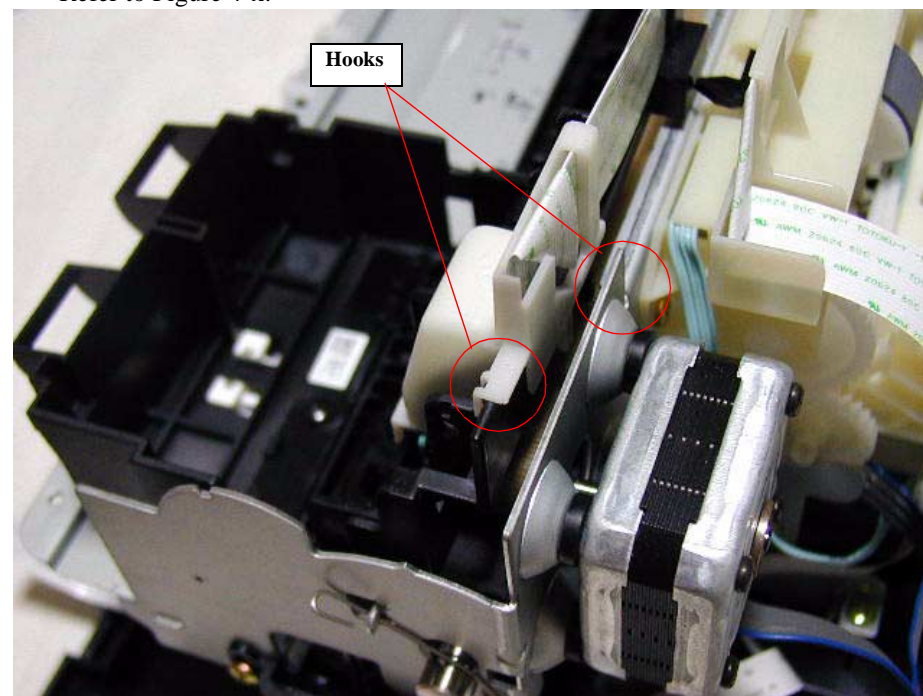

Figure 4-6. Removing the Head FFC Holder

- Disconnect the Printhead's FFC from the connector on the Printhead.

6. Remove two screws (C.B.P-TITE 3x6 F/Zn and +Bind B-TITE SEMS W2 2.5x5 F/Zn) tightening the Printhead.

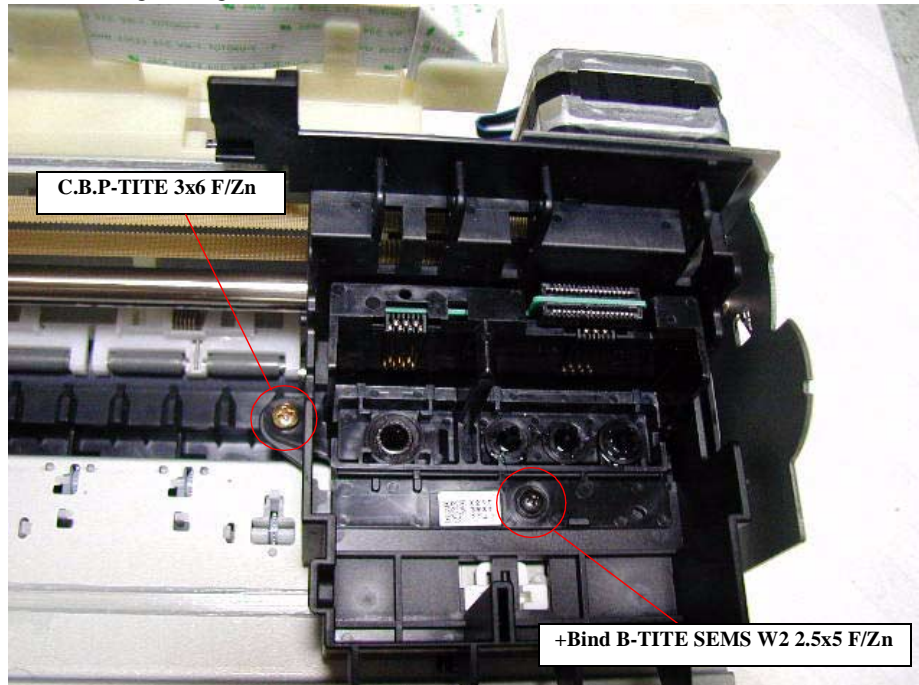

Figure 4-7. Removing the two screws tightening the Printhead

7. Remove the Printhead from the CR unit.



- Place the Printhead's FFC in the cable holder by the four portions indicated in the following Figure 4-8.
- Make sure that the Head Grounding Plate is installed to the carriage correctly. Refer to Figure 4-9.
- Make sure that two holes of the Printhead correctly fit in the installing position pins. Figure 4-9.

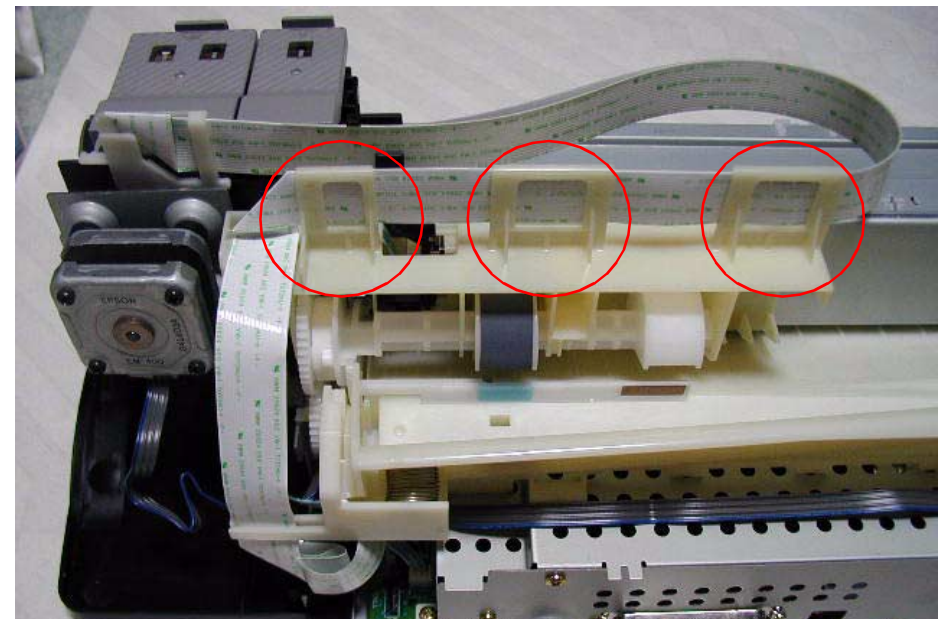
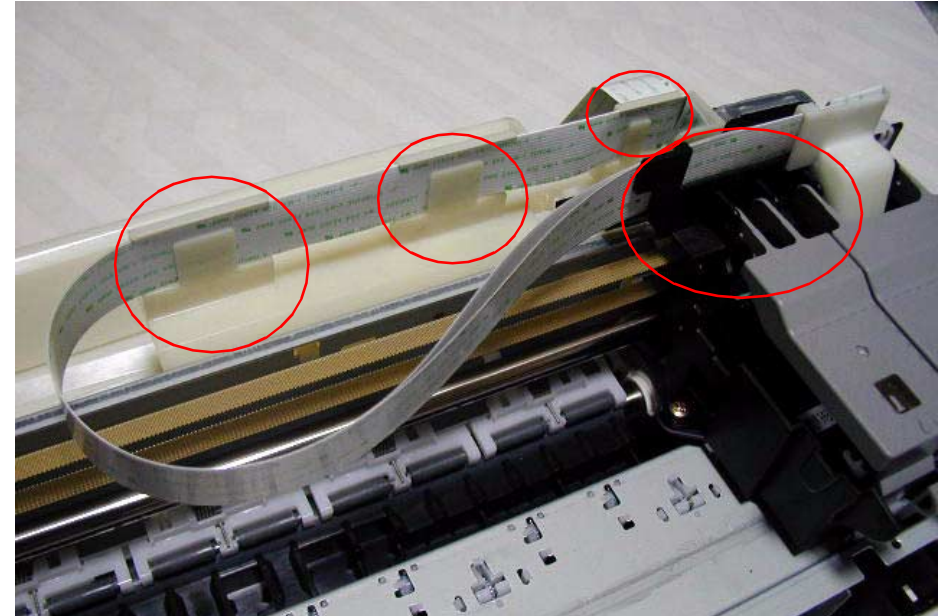

Figure 4-8. Placing the Printhead's FFC

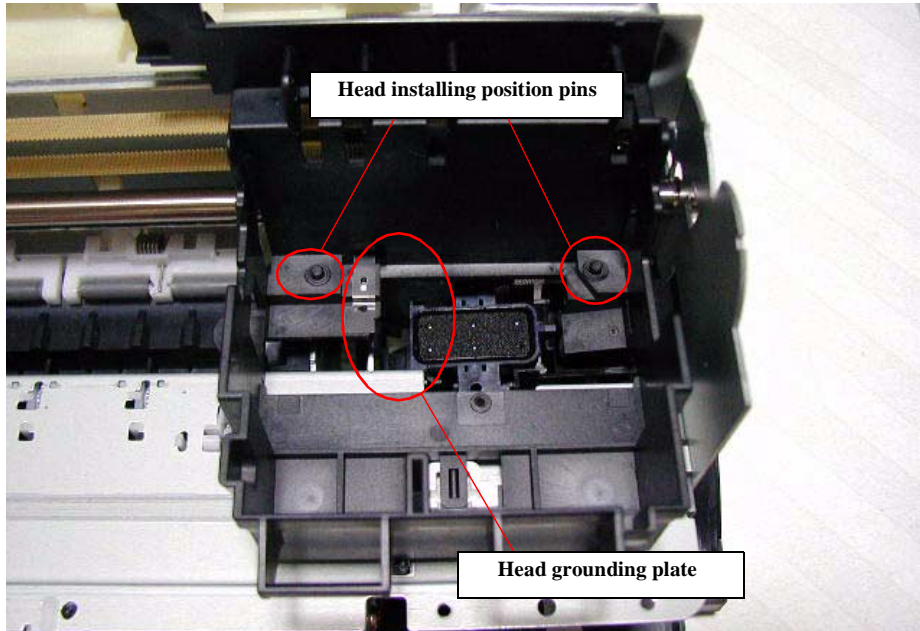

Figure 4-9.

Printrhead installing the position pin & the grounding plate.



- Tightening Torque for screw
- C.B.P-TITE 3x6 screw for printhead: 6+/1kgf.cm



When the Printhead is replaced with a new one, following adjustments must be performed in the order below:

1. Initial ink charge
2. Printhead ID input
3. Bi-d adjustment

When the Printhead is removed and reinstalled, only the following adjustment is required.

1. Head cleaning
2. Bi-d adjustment

4.2.4 CR motor removal

1. Remove the Housing from the printer. (Refer to Section 4.2.1.)
2. Using tweezers or a small screwdriver, slide the CR Lock Lever to front and release the CR Lock Lever from the CR unit. Then move the CR unit to the center area of the CR shaft.
3. Loosen the CR Timing Belt by pushing the Driven Pulley Holder to right using a screwdriver, and remove the Timing Belt carefully from the pinion gear on the CR motor. Refer to Figure 4-xx.

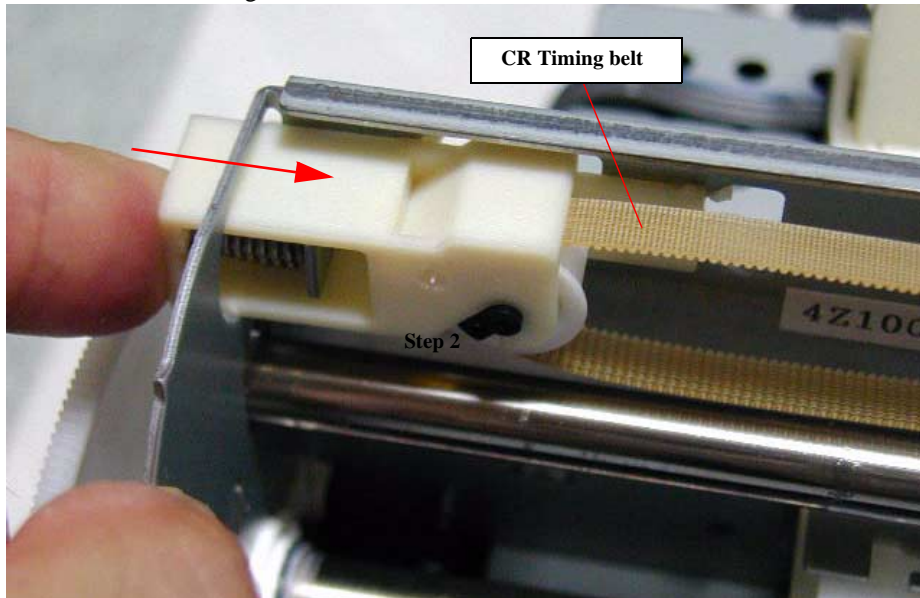

Figure 4-10. Removing the Timing Belt

4. Remove four Hexagon Nuts while holding the CR motor and remove the CR motor assembly. Refer to Figure 4-11.

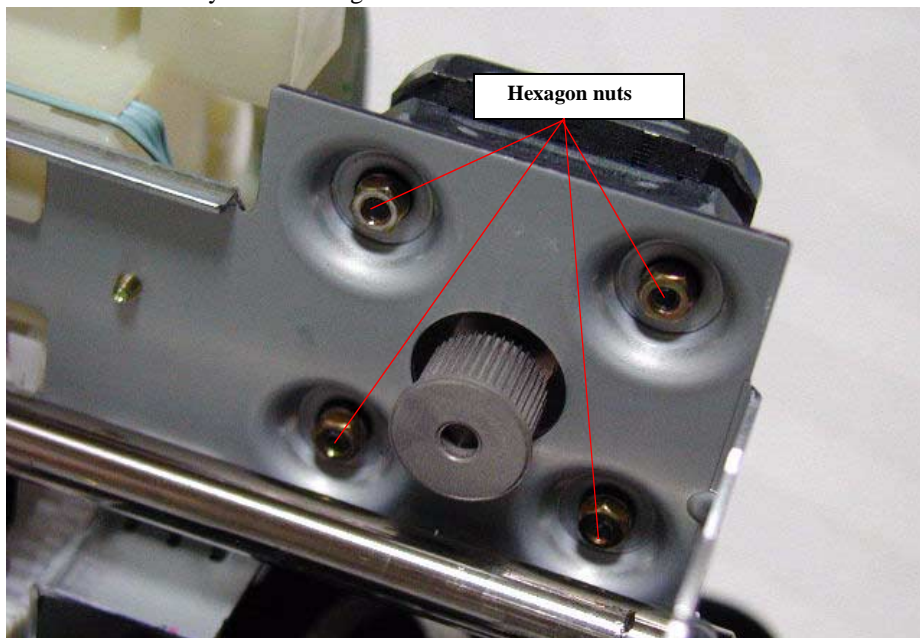

Figure 4-11. Removing the CR motor

5. Take the CR motor's cable out from the cable hook in the Waste drain inkpad unit.
6. Disconnect the CR motor connector cable from the CN12 on the Main board with tweezers.



- The Gap adjustment (Bi-d adjustment) is required when the CR motor is removed or replaced.



- Connect the CR motor connector cable to the CN12 on the Main board. Use of tweezers or pincers is recommended to facilitate the job, since the CN12 is not located near the rear edge of the Main board.

4.2.5 Waste drain ink pad unit removal

1. Remove the Housing from the printer. (Refer to Section 4.2.1.)
2. Remove one screw (C.B.P-TITE 3x8 F/Zn) on the front right side of the printer. (viewed from front side)

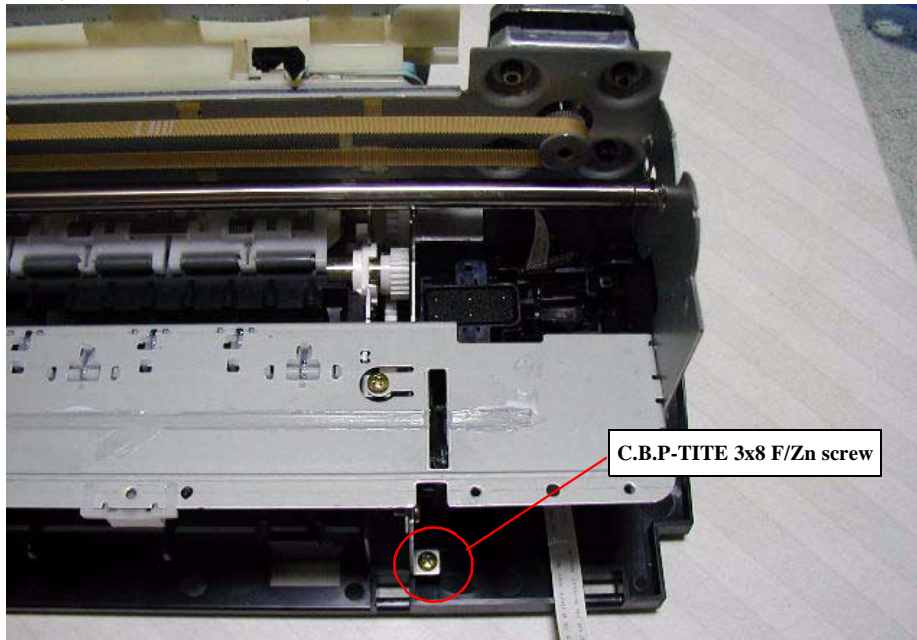

Figure 4-12. Removing one screw securing the Waste ink pad unit

3. Remove two screws (C.B.P- TITE 3x8 F/Zn) and take some cables off from the cable hook in the Waste drain ink pad unit as shown in the following figure.

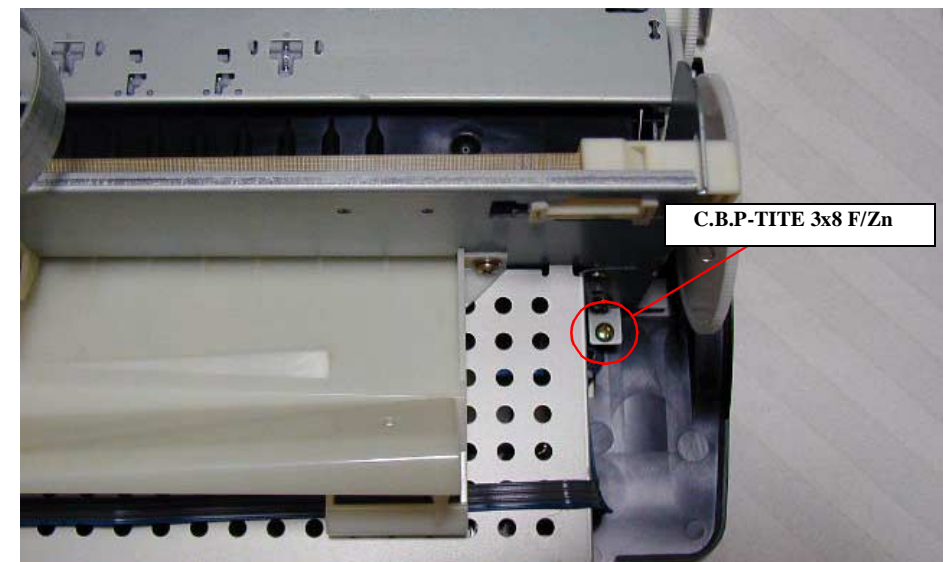
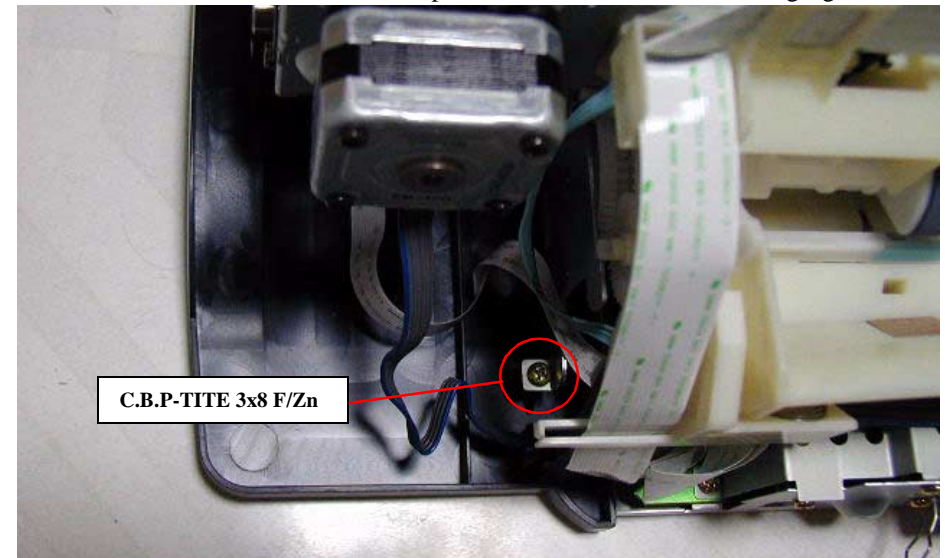

Figure 4-13. Removing one screws & cables at the back side of the printer

4. Remove the Waste drain ink pad unit from the printer

CHECK
POINT

- After assembling the Waste drain ink pad unit, be sure to set the some cables in the cable hook in the Waste drain ink pad unit. Refer to the Figure 4-13.
- When assembling the Waste drain ink pad unit, be sure to set the tip of the waste ink tube in the suitable position of the Waste drain ink pad. Refer to the Figure 4-14.

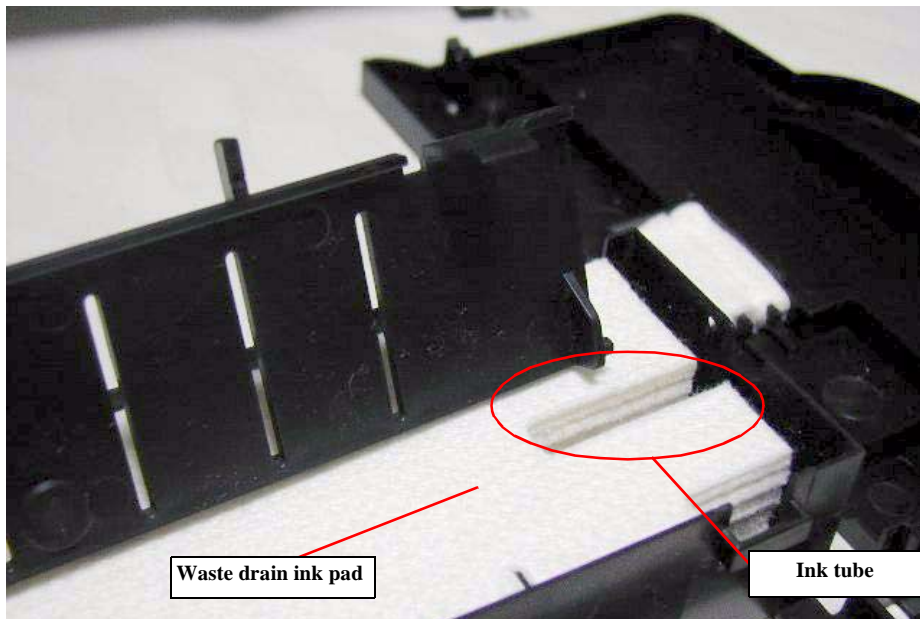

Figure 4-14. Drain ink tube setting position

ADJUSTMENT
REQUIRED

When the Waste drain ink pad is replaced with a new one, following service item is required.

- Waste drain ink counter reset operation.

REASSEMBLY



- Tightening torque for screw
 - C.B.P-TITE 3x8 screw for Waste drain ink pad unit : 9±/1 kgf.cm

4.2.6 Circuit board removal

1. Remove the Housing from the printer. (Refer to Section 4.2.1.)
2. Remove three screws (C.B.S 3x6 F/Zn) securing the Circuit board unit at the front side of the Printer mechanism.

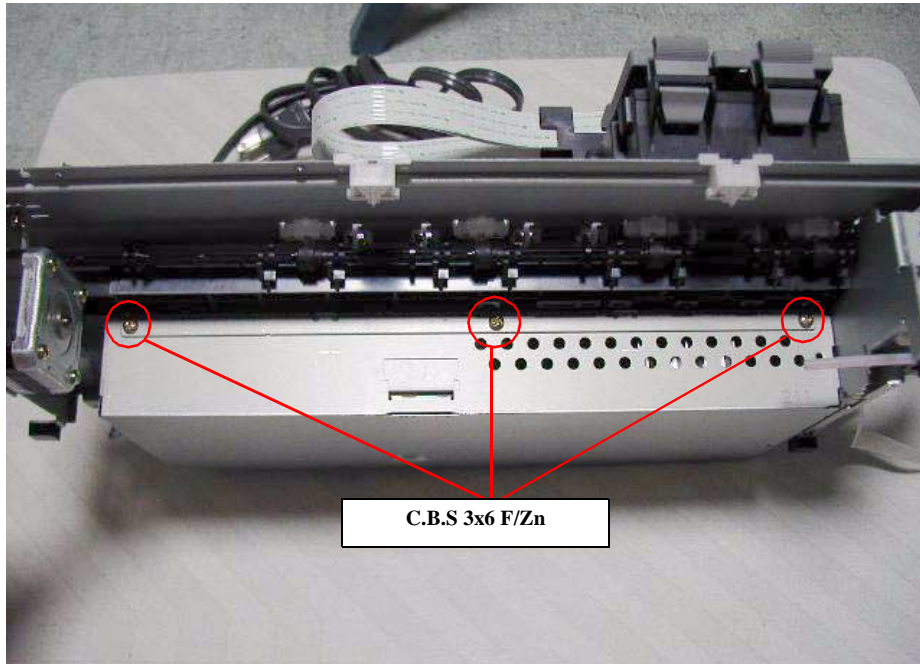

Figure 4-15. Removing four screws at the printer front side

3. Remove four screws (C.B.S 3x6 F/Zn) securing the Circuit board unit at the back side of the Printer mechanism and remove two screws (C.B.S 3x6 F/Zn) securing the Circuit board unit at the right side (viewed from back side).

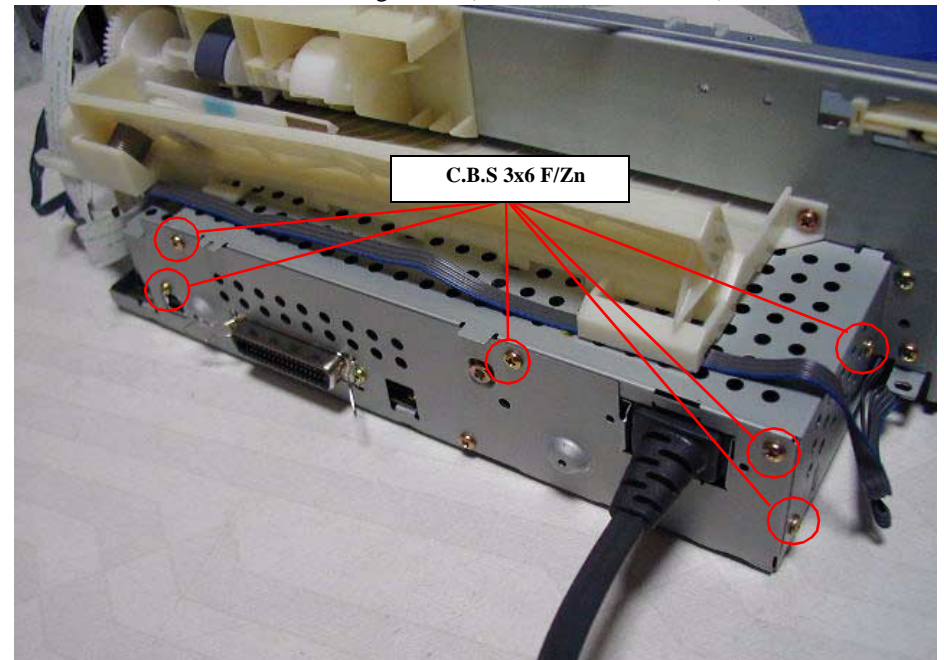

Figure 4-16. Removing six screws at the printer back side & right side

4. Holding the Left housing lightly, pull down the Circuit board unit. Then disconnect the following four cables from the corresponding connectors on the Main board.

- CR motor connector cable : CN12
- PF motor connector cable : CN7
- Printhead FFC : CN8, CN9
- HP/PE sensor cable : CN4

5. Remove the following screws securing each circuit board to the Shield plate. Figure Figure 4-17.

- C383 MAIN : Remove five screws.
 - C.B.S 3x6 F/Zn (Red circled screws) : 3pcs (for Main board)
 - C.P. 3x6 F/Zn (Yellow circled screws) : 2pcs (for Parallel I/F connector)
- C383PSB/E : Remove five screws.
 - C.B.S 3x6 F/Zn (Yellow circled screws) : 3pcs (for PS board)
 - C.B.S-TITE R 3x6 F/UC (Red circled screw) : 1pcs (for PS board)
 - C.B.(O) 4x5 F/ZG for 120V (Green circled screw) : 1pcs (for Earth terminal)
 - Hexagon nut, Normal M4(Green circled) : 1pcs (for Earth terminal)
 - (C.B.S 3x6 F/Zn for 220V (Green circled screw) : 1pcs (for Earth terminal))

NOTE: 110V type of the PS board dose not have earth wire.

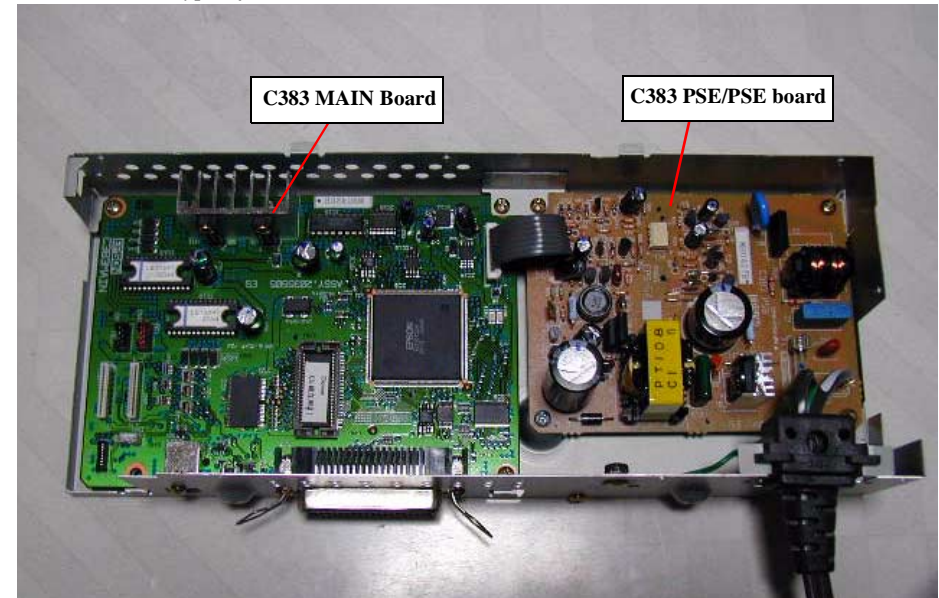

Figure 4-17. Remove the screw securing each circuit board



When replacing the Main board with a new one, perform the following service items.

- Before removing the Main board, connect the parallel I/F or USB Cable and try to read out the following data by using the Adjustment program. If this operation succeeds, replace the Main board and write the read out data to the new Main board through the Adjustment program.
 - 1) I/C Ink consumption counter.
 - 2) Waste ink drain pad counter.
 - 3) Printhead ID input.
 - 4) Gap adjustment (Bi-d adjustment)

In case the above mentioned data are not able to be read out from the defective Main board, perform the following service items.

- Replace the both ink cartridges with a brand new one.
- Replace the Waste ink drain pad with a new one.
- Input the Printhead ID.
- Adjust the Bi-d alignment.



- Since the cable between C383 MAIN board and C383 PSB/E board are directly soldered, take the following steps when replacing only one circuit board in the service activity.
 1. Take off the cable on the Main board by removing the solder by heating it with the soldering iron.
 2. Replace the defective circuit board with new one.
 3. Insert the tip of the cable into the soldering hole of the ASP Main board and solder it securely.
- Tightening Torque for screw

• C.B.S 3x6 F/Zn screw for PS board	: 6+/- 1kgf.cm
• C.B.S-TITE R 3x6 F/Uc screw for PS board	: 6+/- 1kgf.cm
• C.B.S 3x6 F/Zn screw for Main board	: 6+/- 1kgf.cm
• C.P. 3x6 F/Zn screw for Parallel I/F connector	: 6+/- 1kgf.cm
• C.B.S 3x6 F/Zn screw for Circuit unit	: 6+/- 1kgf.cm
• C.B.(O) 4x5 F/ZG screw for Earth cable	: 11+/-1kgf.cm



When replacing or removing the PS board, be sure to use the following suitable screw to secure the PS board.

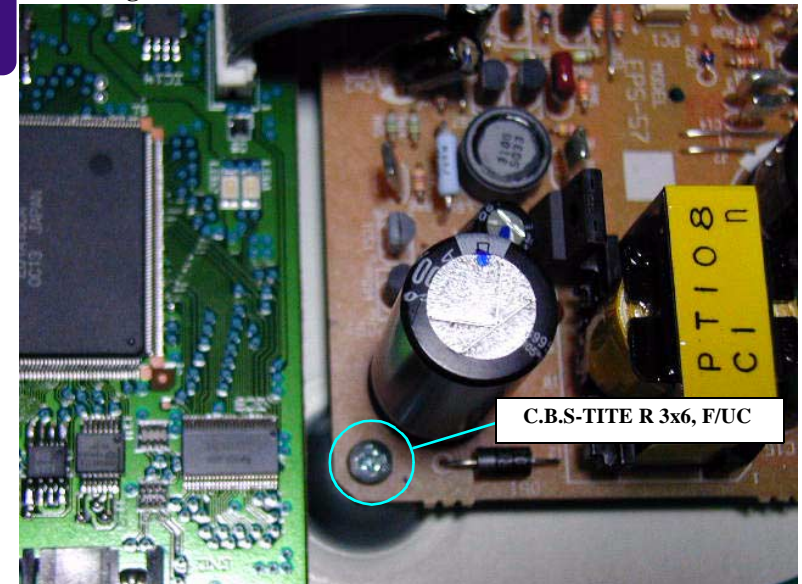

Figure 4-18. PS board fixing screws

- Install a new cartridge before sending back the printer to the user, since the ink cartridge once taken out can not be used again.
- Installation of I/C must be carried out by I/C replacement sequence. Otherwise, ink may not eject properly.



Check the Earth terminal and wire position. Refer to the following figure. The earth wire for 120V must be placed back side of the Heat sinker HT1. Be sure to leave at least 2.5 mm of space between heat sink HT1 and the wire. If this is not possible, secure the wire with tape or other method to be sure that a minimum of 2.5 mm spacing is preserved. And the earth wire for 220V must be placed in front of the Heat sinker HT1 as following figure.

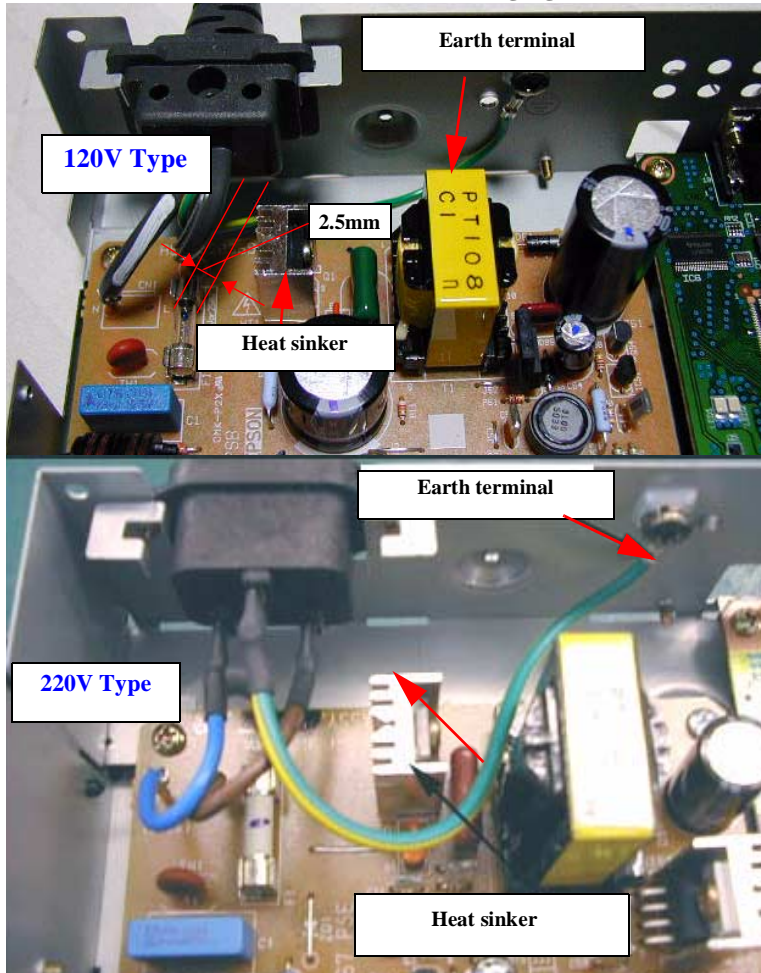

Figure 4-19. Earth terminal and wire position

4.2.7 LD Roller removal

1. Remove the Housing from the printer. (Refer to Section 4.2.1.)
2. Take the Head FFC off from the Head FFC holder located along the LD roller shaft holder.

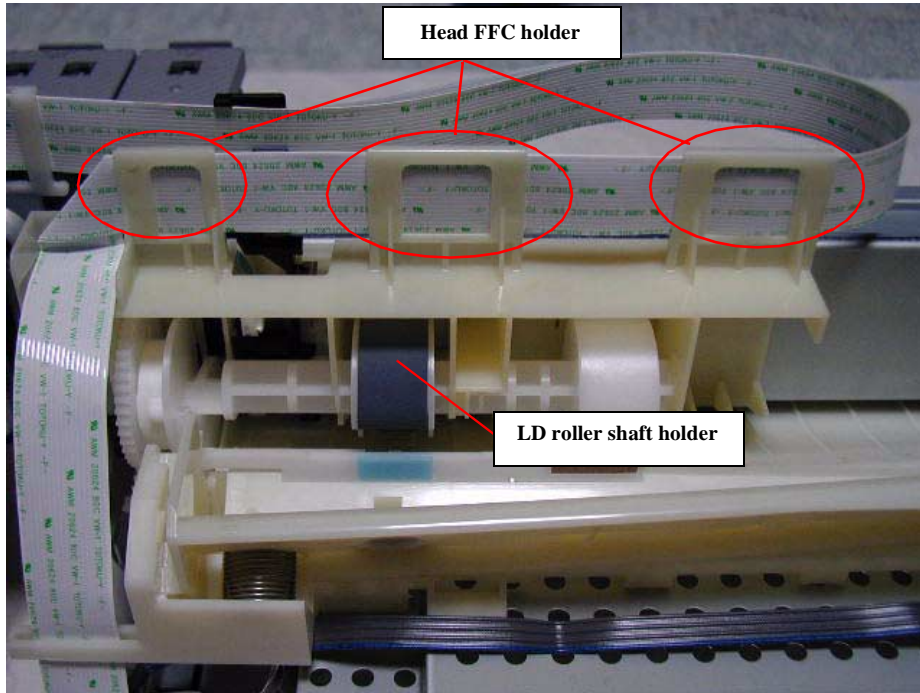

Figure 4-20. Taking Head FFC out from the FFC holder

3. Remove two screws (C.B.S 3x6 F/Zn) securing the LD roller holder to the Main frame.

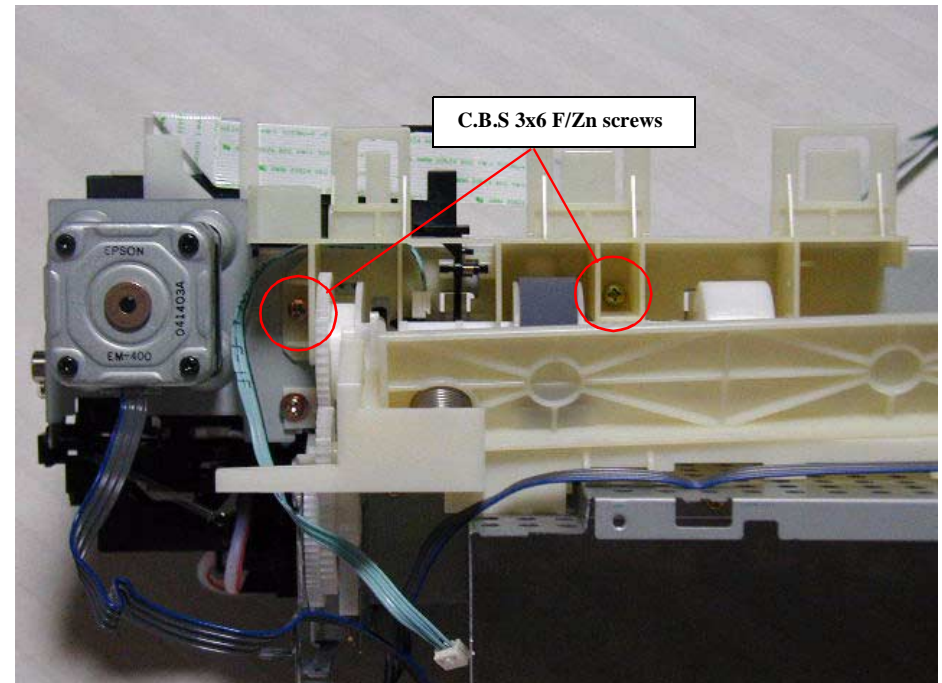

Figure 4-21. Removing two screws securing the LD roller holder

4. Push the two hooks of the LD roller shaft holder as shown in the following figure.
5. Pull the LD roller shaft holder unit upward from the Main frame.

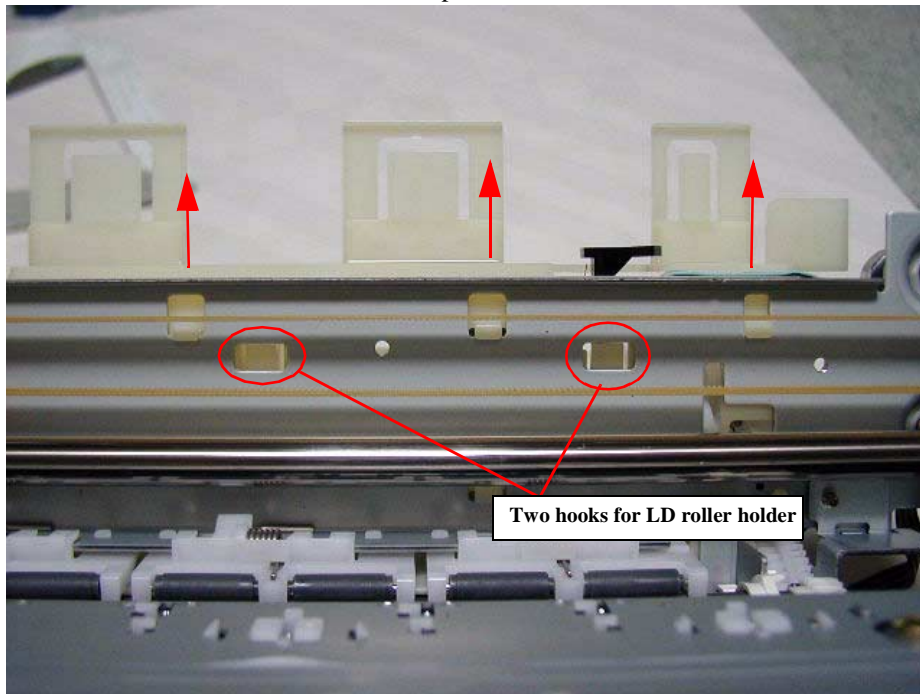

Figure 4-22. Pushing two hooks of the LD roller shaft holder

6. Remove the LD roller along with the Clutch mechanism from the LD roller shaft holder unit.

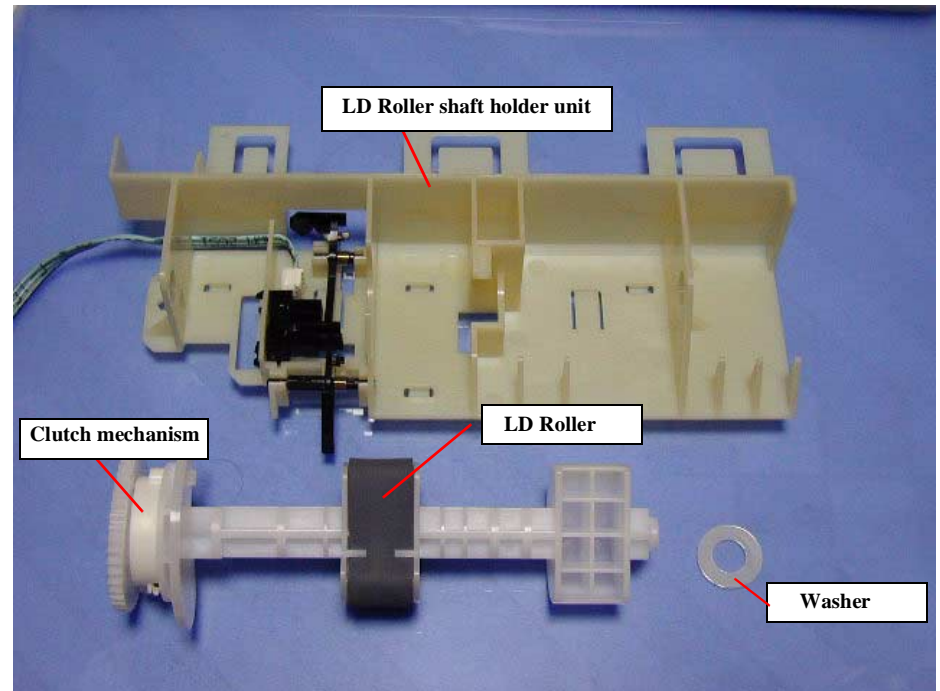

Figure 4-23. Removing the LD roller with Clutch mechanism

CAUTION



- Do not damage the tooth of the Spur gear 35.2 and the Spur gear 23.2 when assembling the LD roller shaft holder unit.

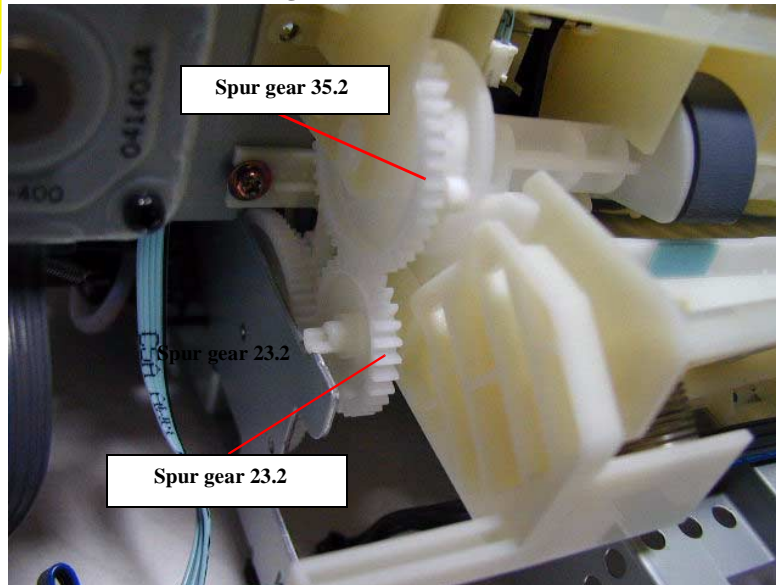

Figure 4-24.

Spur Gear 23.2 and Spur Gear 35.2



- Before assembling the LD roller shaft, make sure that the round hole of the Clutch is set on the protrusion on the LD roller shaft as shown in the following figure.

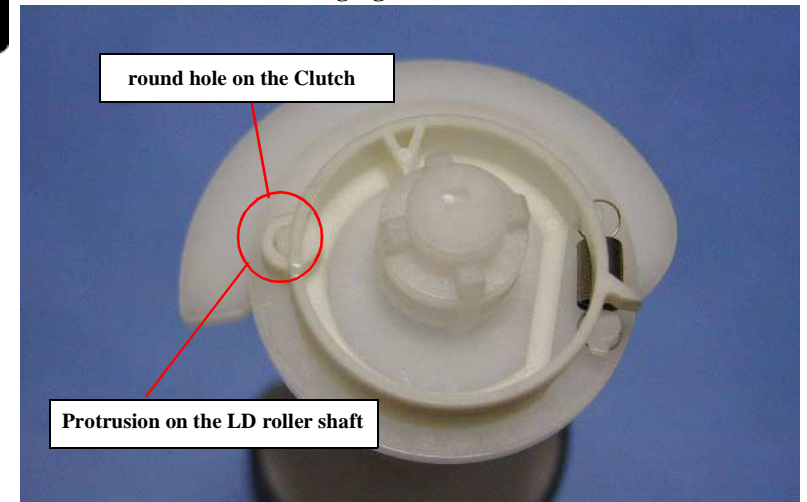

Figure 4-25. Assembling the Clutch

- Assemble the LD roller shaft holder unit to the printer mechanism in the following procedure.
 - 1) Set the tip of the Change lever to the printer front side.

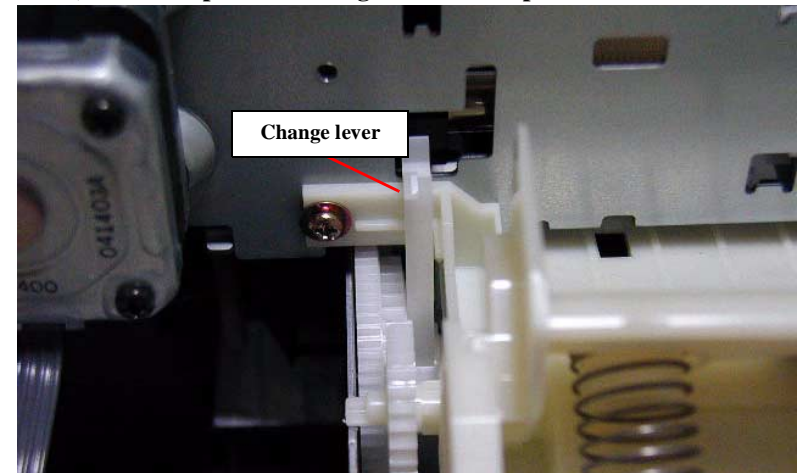

Figure 4-26. LD Roller shaft holder assembling procedure (1)



- 2) Assemble the LD roller shaft holder unit while storing the Paper return plate into the ASF frame.

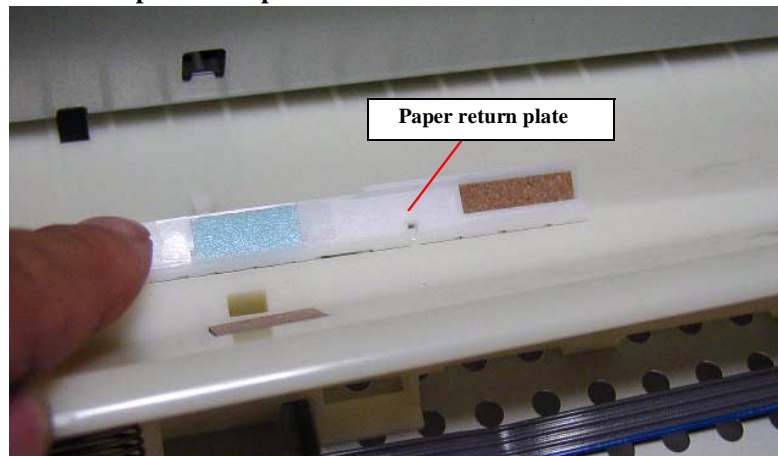

Figure 4-27. LD Roller shaft holder assembling procedure (2)

- Fasten the LD roller shaft holder with two C.B.S 3x6 F/Zn screws in the order indicated in the following figure.

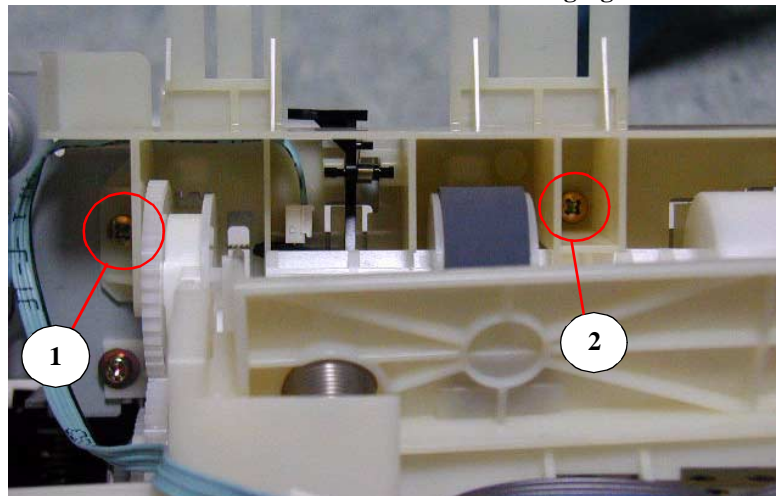

Figure 4-28. Fastening the LD roller shaft holder

- Tightening torque for screw
C.B.S 3x6 F/Zn screw for LD roller shaft holder unit : 9+1 kgf.cm

4.2.8 HP/PE Sensor removal

1. Remove the Housing from the printer. (Refer to Section 4.2.1.)
2. Remove the LD roller from the LD roller shaft holder. (Refer to Section 4.2.7.)
3. Remove HP detection lever from the LD roller shaft holder and disconnect the cable from the sensor connector.

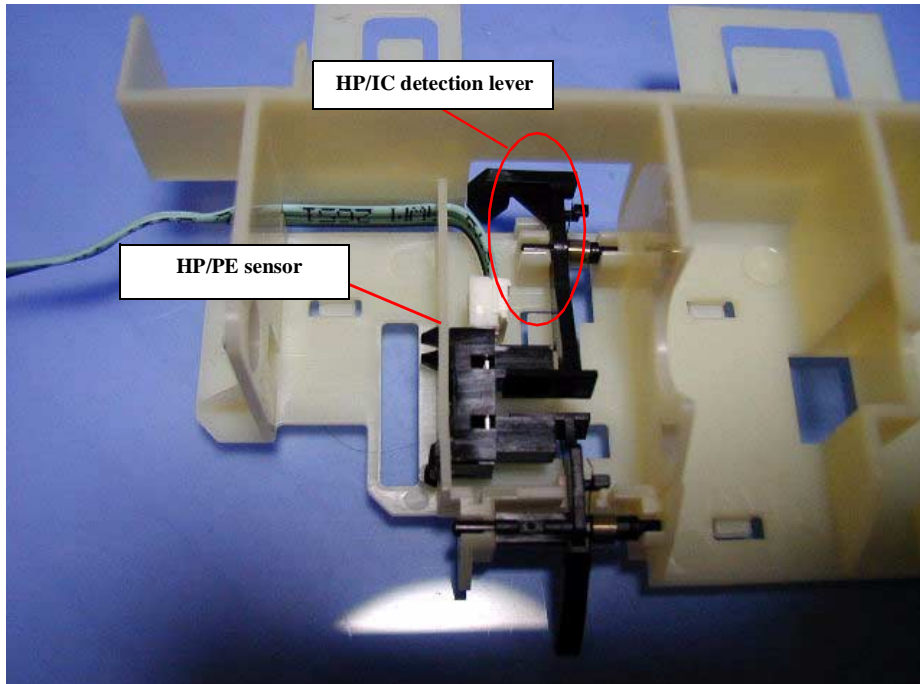

Figure 4-29. Removing the HP detection lever

4. Release the two fixing hooks for the sensor from the LD roller shaft holder and remove the sensor.

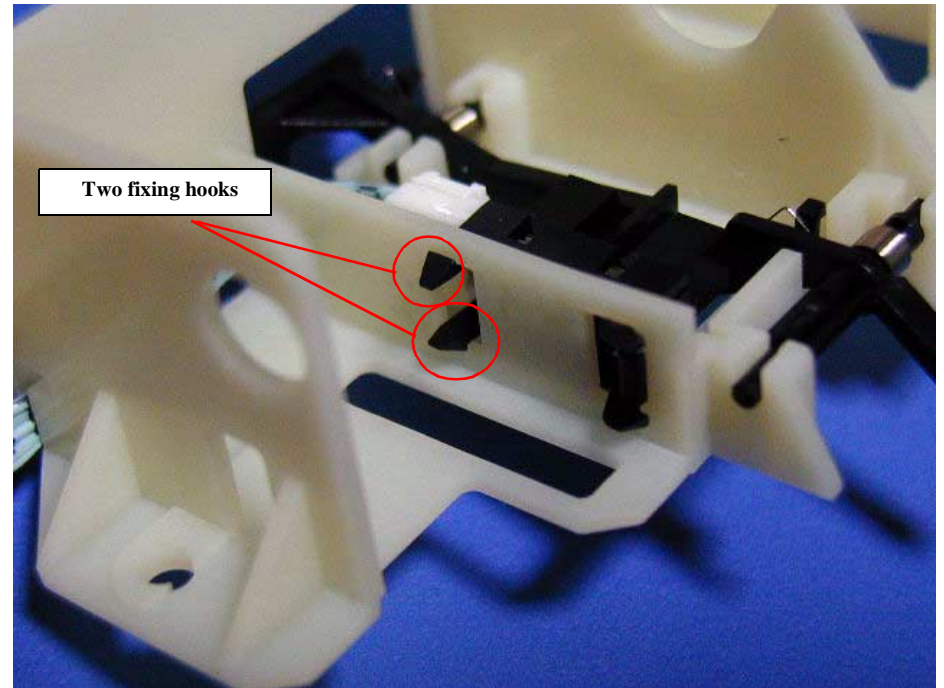

Figure 4-30. Releasing two fixing hooks for the sensor



- Make sure that the Torsion spring 0.22 is hung to the following suitable position.

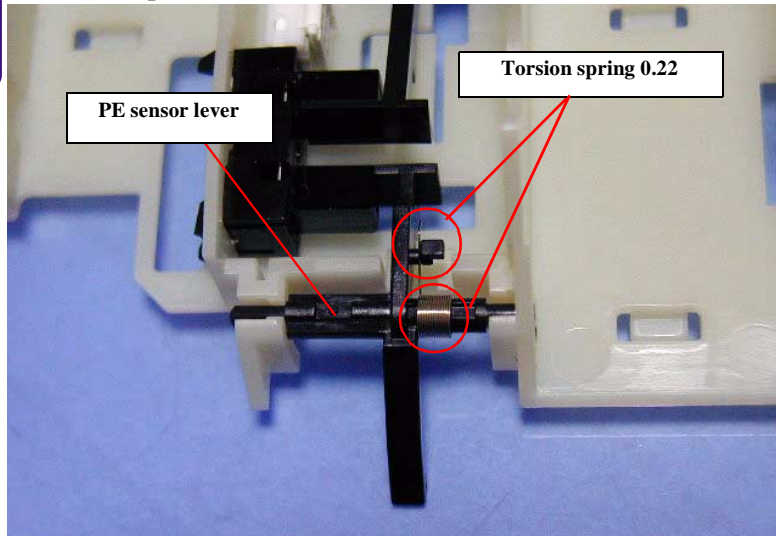

Figure 4-31. Torsion spring 0.22 for PE detection lever

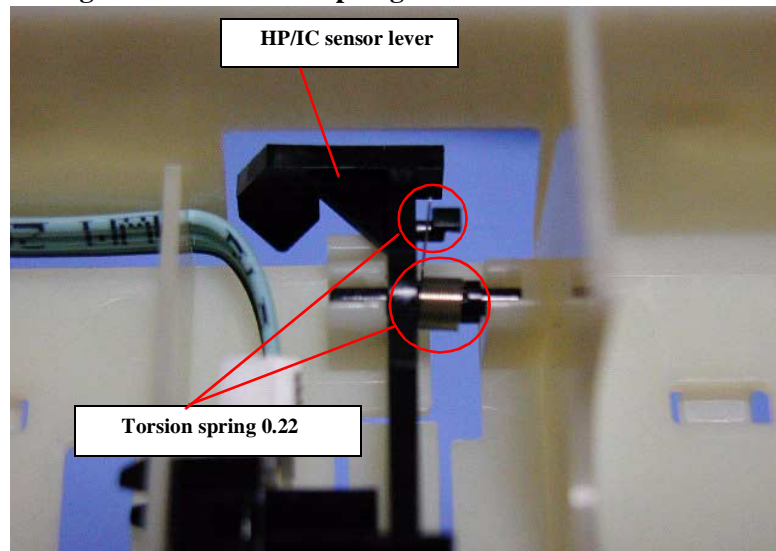

Figure 4-32. Torsion spring 0.22 for HP detection lever



- Make sure that the HP/PE sensor cable is placed to the suitable groove on the LD roller shaft holder.

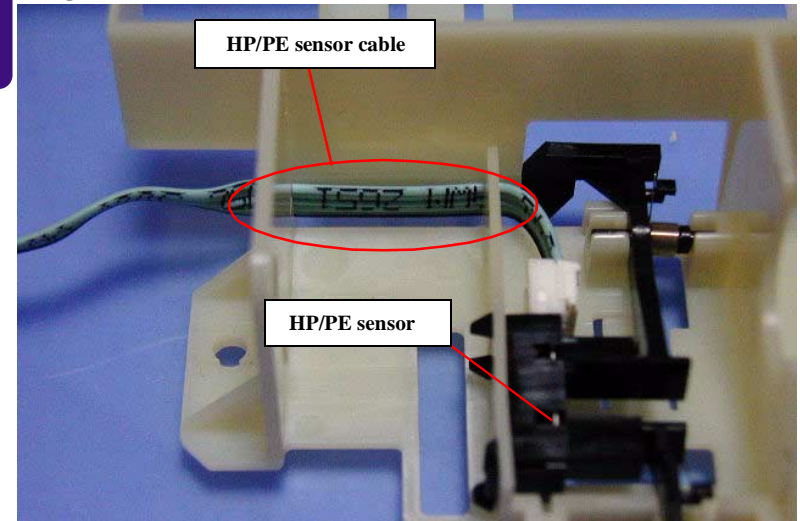

Figure 4-33. Sensor cable placing position (1)

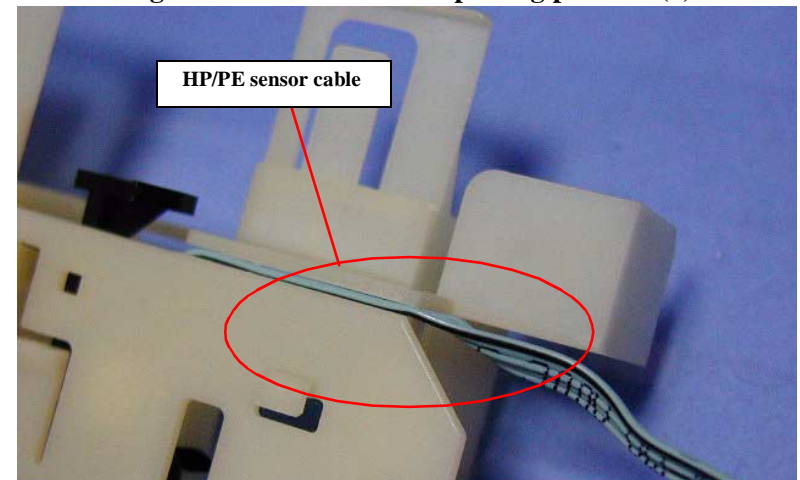

Figure 4-34. Sensor cable placing position (2)

- Make sure that the each sensor lever turn back smoothly by moving it after the sensor was assembled to the LD roller shaft holder.

4.2.9 Ink system unit removal (Cap & Pump unit)

1. Remove the Housing from the printer. (Refer to Section 4.2.1.)
2. Remove the Waste drain ink pad from the printer. (Refer to Section 4.2.6.)
3. Remove the LD roller holder from the Printer. (Refer to Section 4.2.8.)
4. Remove three screws (C.B.S 3x6 F/Zn) securing the Ink system frame and the Cap assembly to the frame.

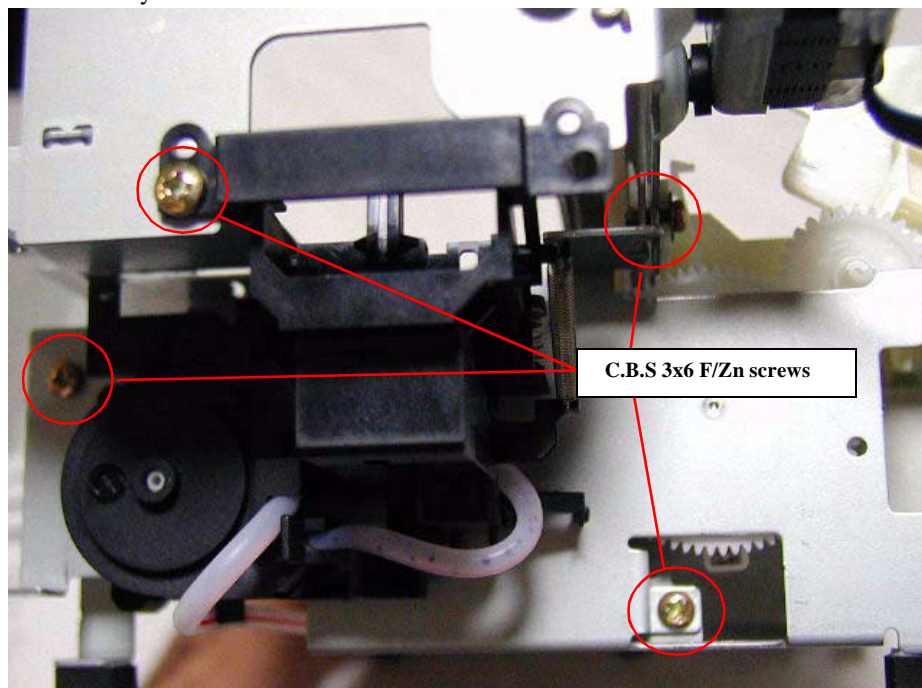

Figure 4-35. Removing three screws securing the Ink system

5. Remove the Ink system unit (Cap and Pump unit) carefully along with the Ink system frame.

CAUTION



When the Ink system unit is removed, be careful that the gears do not come off from each shaft on the Ink system frame.

6. Release one hook for Cap assembly on the Ink system frame and take the Cap assembly out from the Ink system frame.
7. Disconnect the waste drain ink tube carefully from the bottom of the Cap assembly.

CAUTION



- Since the compression spring is included in the Pump assembly, watch out for the spring and the gear that pop out from the unit when the Pump assembly is removed from the Ink system unit.
- When replacing the cleaner head built in the Pump assembly, be careful of the following points.
 - 1) Do not touch the cleaner head with your bare hands. Wear gloves or use tweezers.
 - 2) Do not smear the head cleaner with oil or grease.
- When installing the Cleaner head, set the rubber side (black side) facing toward the right side of the frame.
- When installing the Cleaner head, set the two square cut offs on the Cleaner head into the two hooks on the Ink system.

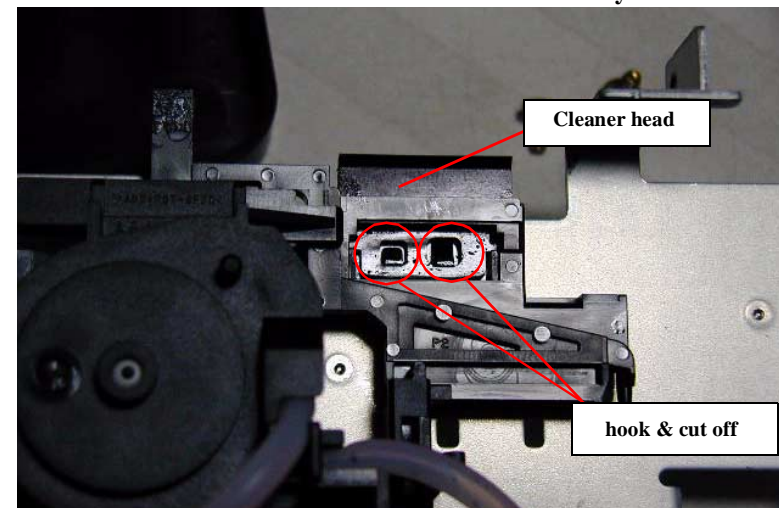

- When replacing the Cap Assembly, do not touch the sealing rubber portion of the Cap Assembly.
- The component parts in the Pump Assembly are not individually supplied as ASP. So please replace the whole Pump Assembly when replacing the Pump Assembly.
- Be careful not to crush or leave any stress on the ink tube connecting the pump assembly and the cap assembly.



- Make sure that all gears are set in each gear shaft on the Ink system frame.

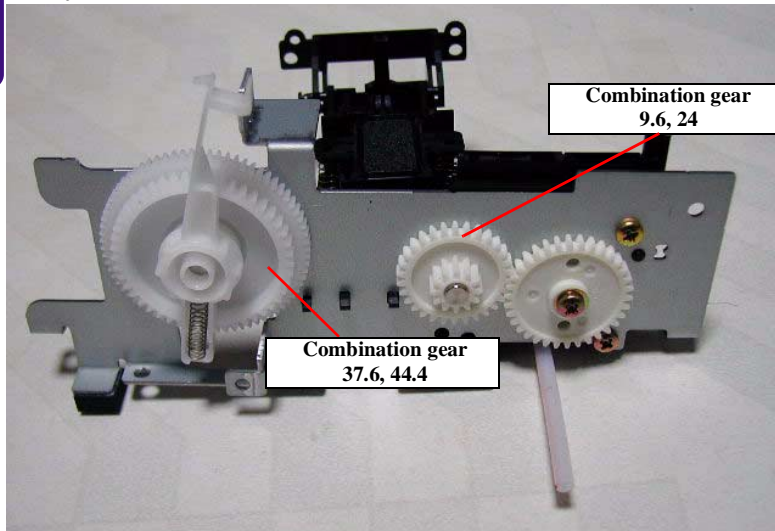

Figure 4-36. Gear engagement on the Ink system frame

- Make sure that the ink tube is placed along the following position.

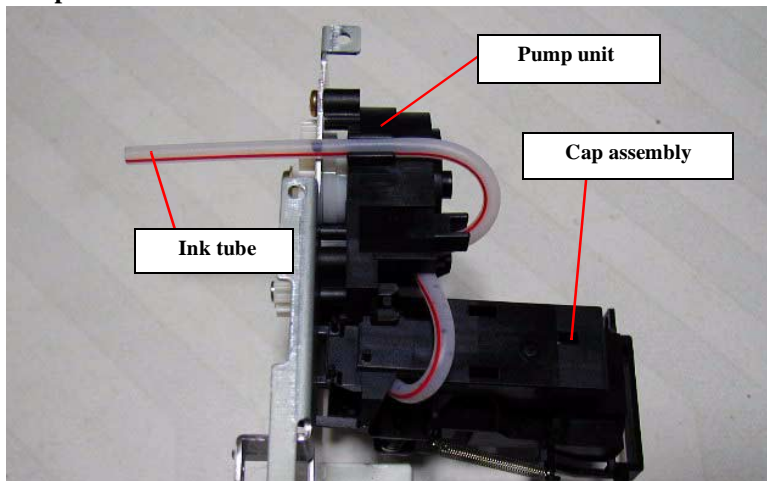

Figure 4-37. Ink tube placing position

- After installing the Pump Assembly, ensure that the cleaner parts move back and forth by rotating the Gear.



- Tightening torque for screw
 - C.B.S 3x6 F/Zn screw for Ink system frame & Cap assy.: 9+/1 kgf.cm

4.2.10 Paper Eject Roller removal

1. Remove the Housing from the printer. (Section 4.2.1 Housing removal)
2. Remove three screws (C.B.S 3x6 F/Zn) securing the Front frame to the Main frame.

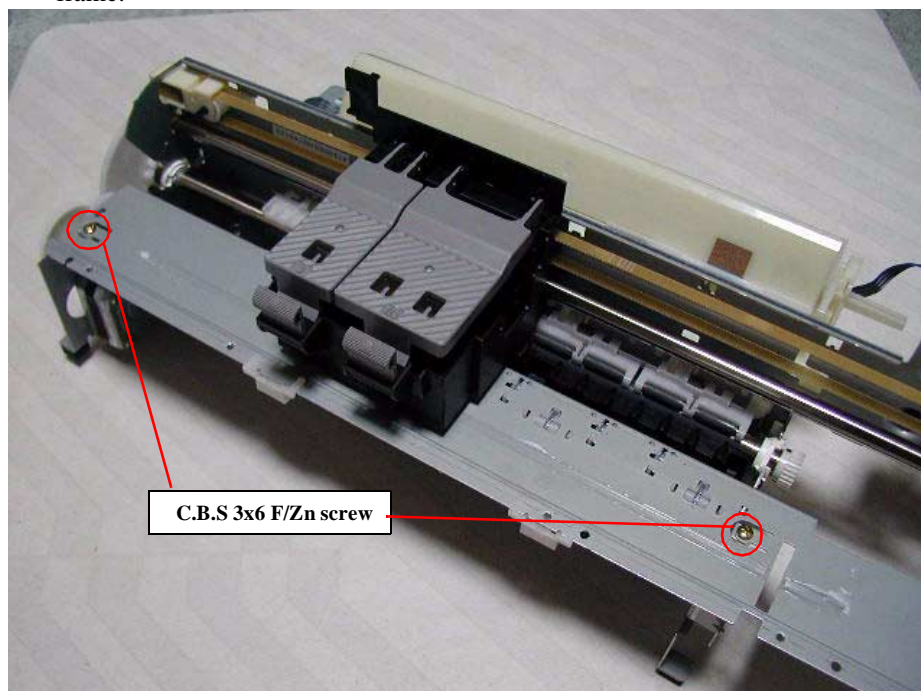

Figure 4-38. Removing the Front frame

3. Lift up the right side of the Front frame and slide it to the left side a little bit and then remove it.

CAUTION



When removing the Front frame, if the CR unit is out of the CR home position, the nozzle surface of the Printhead may come in contact with Paper guide front as soon as the Front frame is removed. This is because the CR unit is held with this frame. Therefore, be sure to set the CR unit in the CR home position before removing the Front frame. Otherwise, the dot missing problem may occur.

4. Remove the Plain washer and then remove the Combination gear 11.6, 36.8 carefully. Refer to Figure 4-xx.

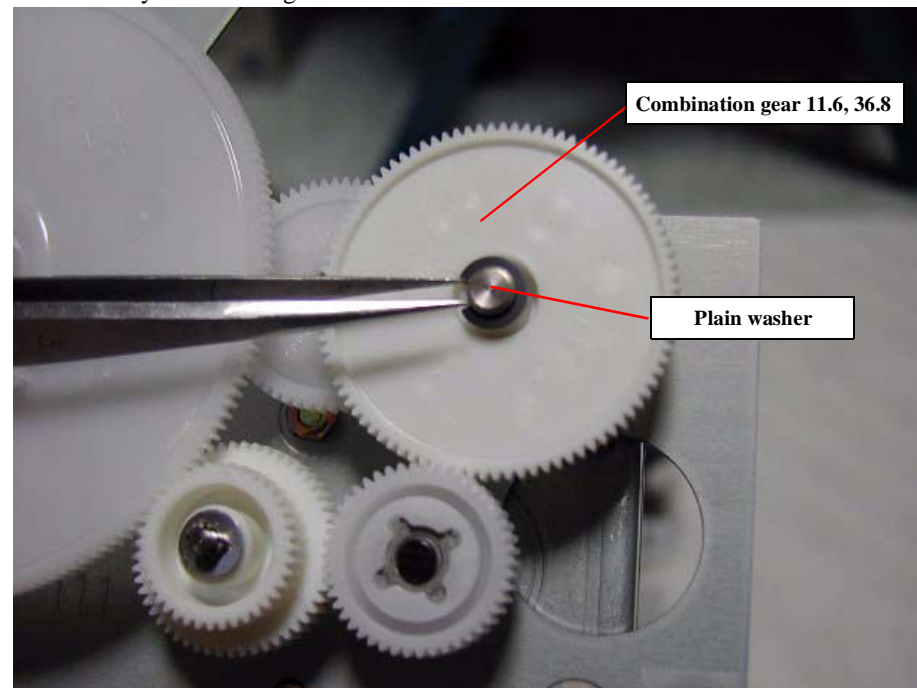
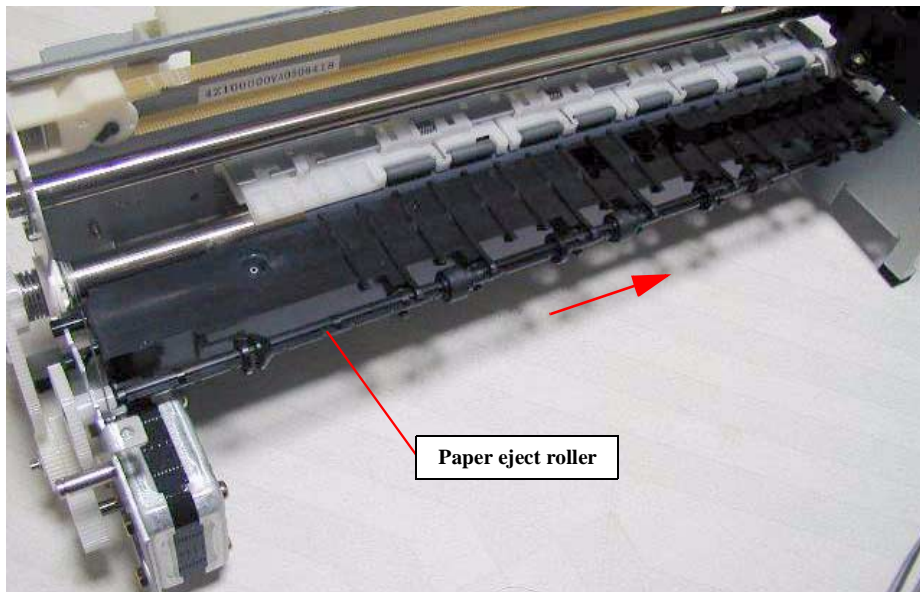
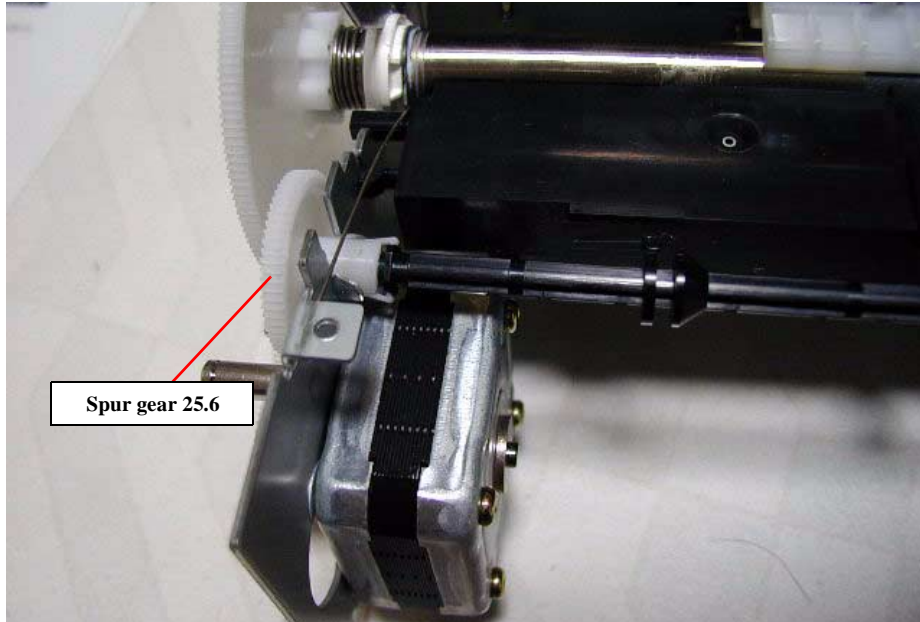
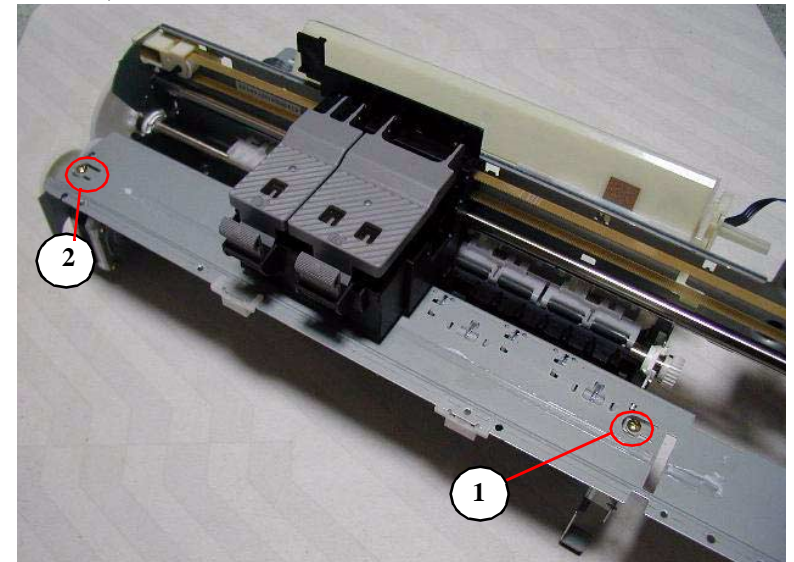

Figure 4-39.

5. Open the spur gear 25.6 hook with a pair of tweezers and then slide the paper eject roller to the right while pulling it toward to remove it.



- When you replace the Frame front, make sure to lubricate the specific amount of G26 to the Frame front. Refer to the Chapter 6 Figure6-5.
- When you replace the Paper eject roller with new one, make sure to lubricate the specific amount of G26 to the Spur gear 25.6. Refer to the Chapter 6 Figure.
- Assemble the Paper eject roller in the following procedure.
 1. Set the Spur Gear 25.6 to the cut out hole in the Main frame.
 2. Align the shape with the spur gear 25.6 hole, insert the paper eject roller shaft, and then press the spur gear 25.6 hook until it is closed.
 3. Slide the paper eject roller and then insert it in the shaft guide holder.
- When you assemble the Front frame to the Printer mechanism, set the CR unit to the left side and assemble the Front frame from the right side. Be careful not damage the CR lock lever.
- Fasten the Front frame with C.B.S Screw 3x6 F/Zn in the order of 1,2.



- Tightening torque for screw
 - C.B.S 3x6 F/Zn screw for Front frame : 9+/-1 kgf.cm

4.2.11 PF motor removal

1. Remove the Housing from the printer. (Refer to Section 4.2.1.)
2. Remove the Waste drain ink pad unit from the printer. (Refer to Section 4.2.6.)
3. Remove the Front frame and Paper eject roller. (Refer to Section 4.2.10.)
4. Remove the Plain washer and then remove the Combination gear 11.6, 36.8 carefully. Refer to Figure 4-38.

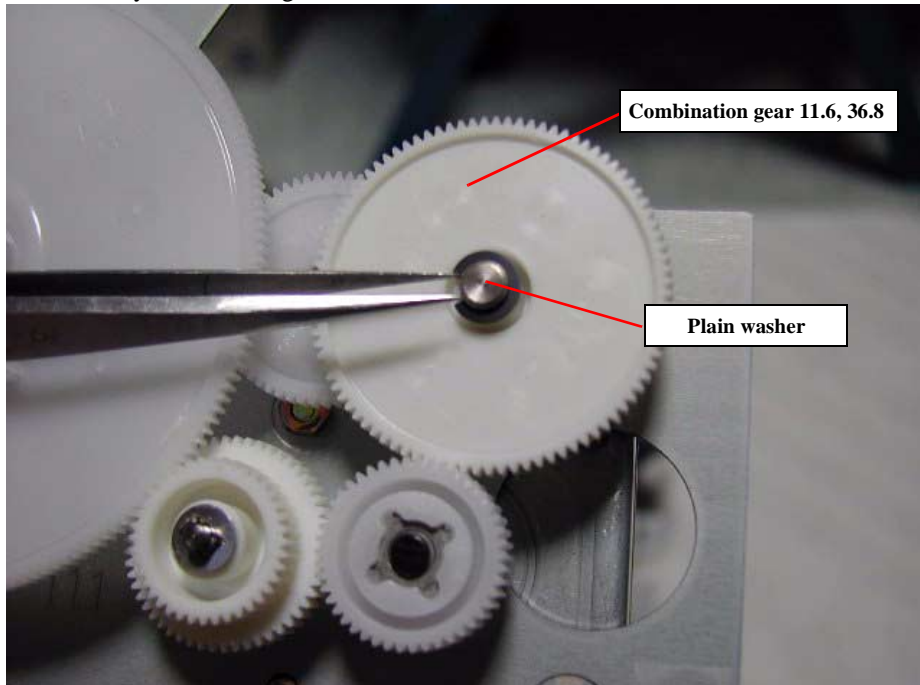

Figure 4-40. Removing the Plain washer and Combination gear 11.6, 36.8

5. Remove three nuts (Hexagon Nut M3) securing the PF motor to the left frame.

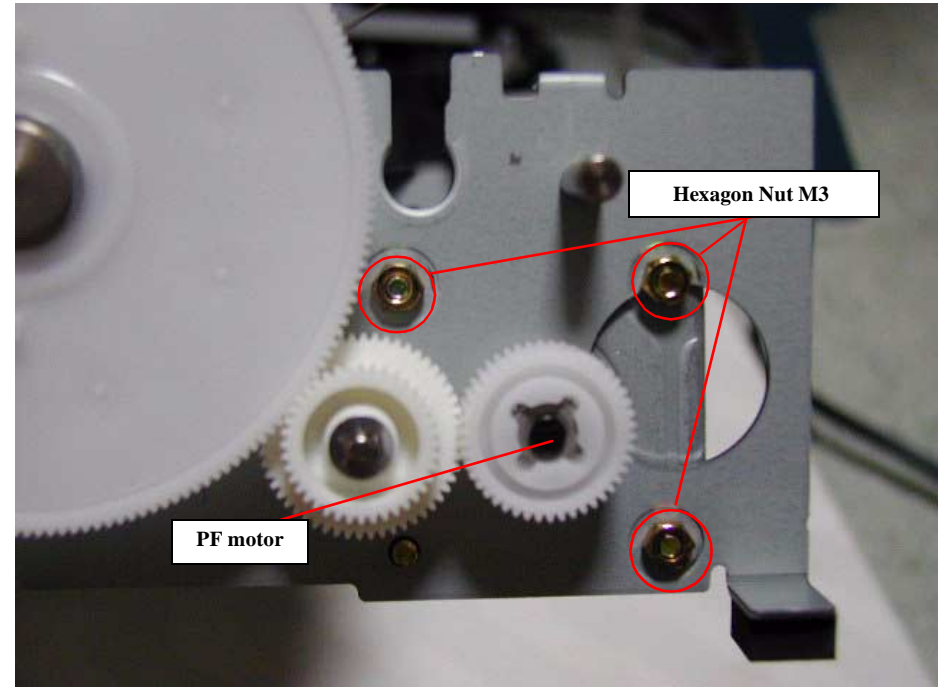

Figure 4-41. Removing two screws securing the PF motor

6. Disconnect the connector cable for PF motor from CN7 on the Main board.
7. Remove the PF motor from the left frame.

**CHECK
POINT**

Be sure that the PF motor cable is placed to the backward. Refer to the Figure 4-42.

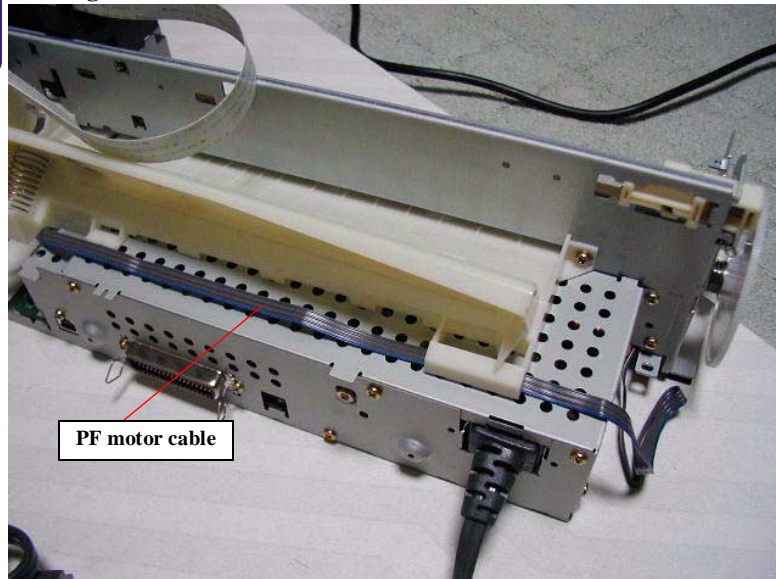

Figure 4-42. PF motor cable

REASSEMBLY

- Since the CN 7 is not located near the rear edge of the Main board, it is easier to use the tweezers or pincers to connect the cable to the CN7.
- Tightening torque for screw
 - Hexagon Nut M3 for PF motor : 9+/-1 kgf.cm

4.2.12 CR unit removal

1. Remove the Housing from the printer. (Refer to Section 4.2.1.)
2. Remove the CR timing belt from the CR pinion gear. (Refer to Section 4.2.4.)
3. Release the Printhead FFC from the cable holders on the LD roller shaft holder. And disconnect the Printhead FFC from the connectors CN8 and CN9 on the Main board.

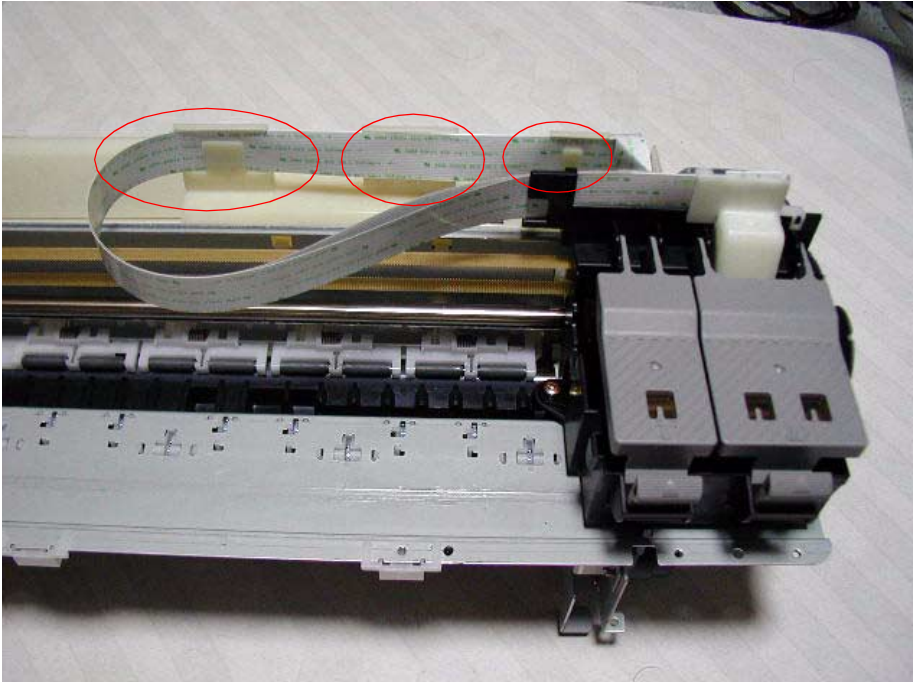

Figure 4-43. Taking Printhead FFC off

4. Release two CR guide shaft rod springs from the both hooks on the left and right sides of the Main frame.

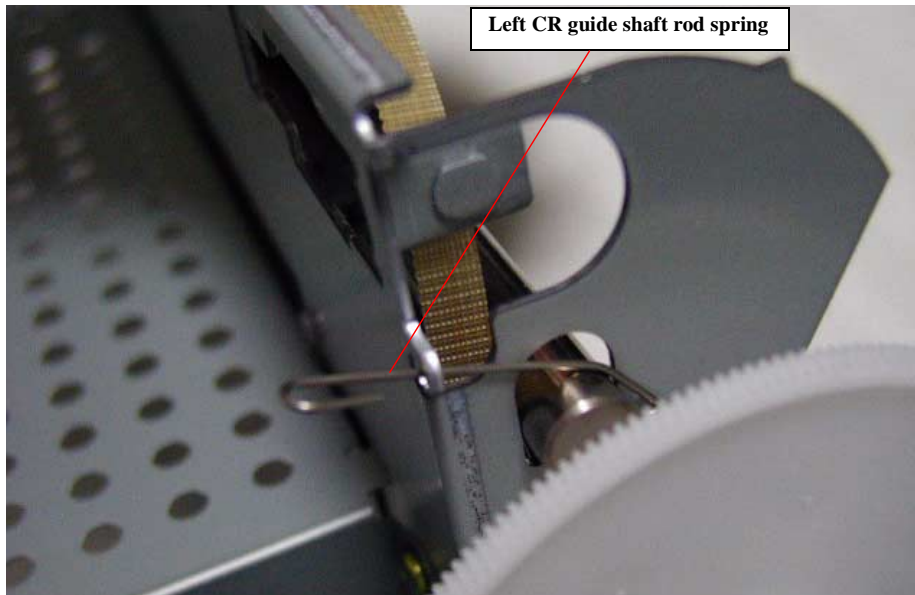

Figure 4-44. Release Left Rod spring for CR shaft

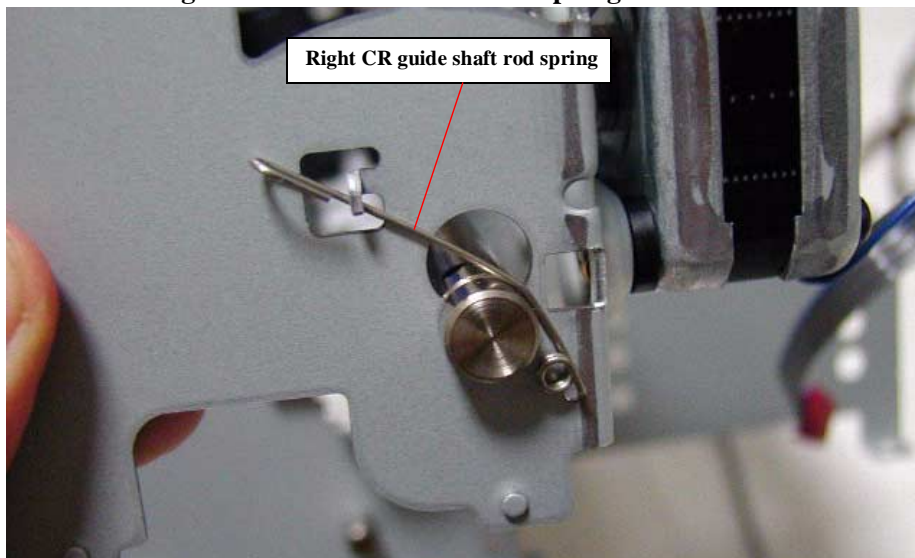

Figure 4-45. Release Right Rod spring for CR shaft

5. Pull the left edge of the CR guide shaft upward to align it with the round cutout portion. Then, holding the CR unit by hand, remove the CR guide shaft by sliding it to left or right.

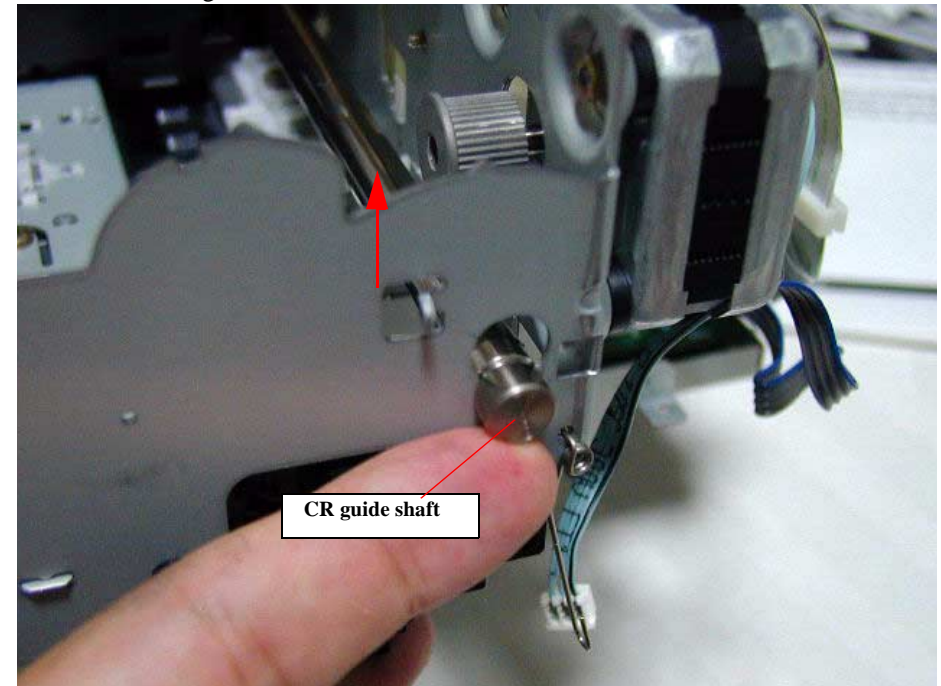

Figure 4-46. Removing the CR guide shaft

CAUTION



Remove the CR guide shaft while holding the CR unit by hand. If you remove the CR guide shaft without holding the CR unit, the nozzle surface of the Printhead may come in contact with the Paper guide front, which causes the dot missing problem.



- Unlike the previous products, the oil pad is not built in the CR unit.
- Make sure that the tips of the CR guide shaft rod springs are set in the holes in the Main frame.
- Make sure that the CR guide shaft rod springs are correctly set in the suitable position. Refer to Figure 4-44, Figure 4-45.
- If you disassemble the CR unit after removing the CR unit from the printer, make sure that the CR Grounding plate is assembled in the suitable position in the CR unit. Refer to Figure 4-47.
- Make sure that the CR slider is assembled on the CR unit.

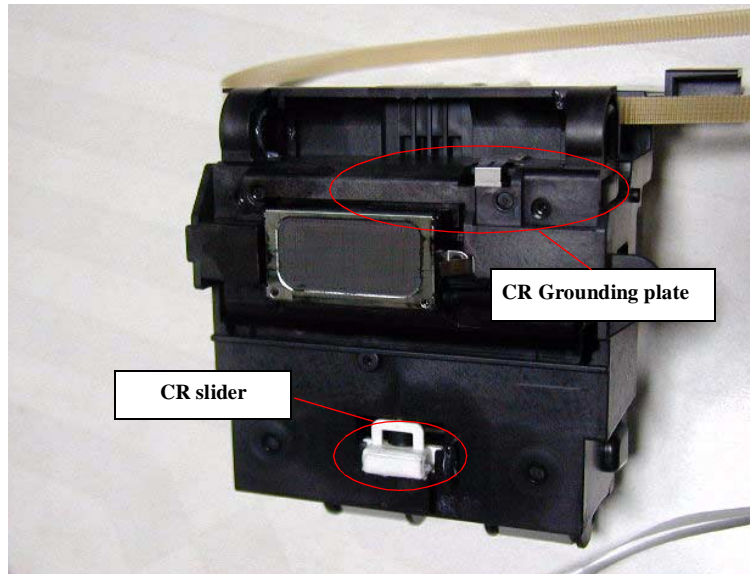

Figure 4-47. Grounding plate assembling position

- If you remove the Printhead from the CR unit, make sure that the Head grounding plate is set in the CR unit. Refer to Figure 4-9.
- Make sure that the groove on the CR guide shaft must be set to the left side.



- If the CR unit is disassembled or replaced with a new one, make sure that the CR timing belt is set in the assembling groove correctly as following figure.

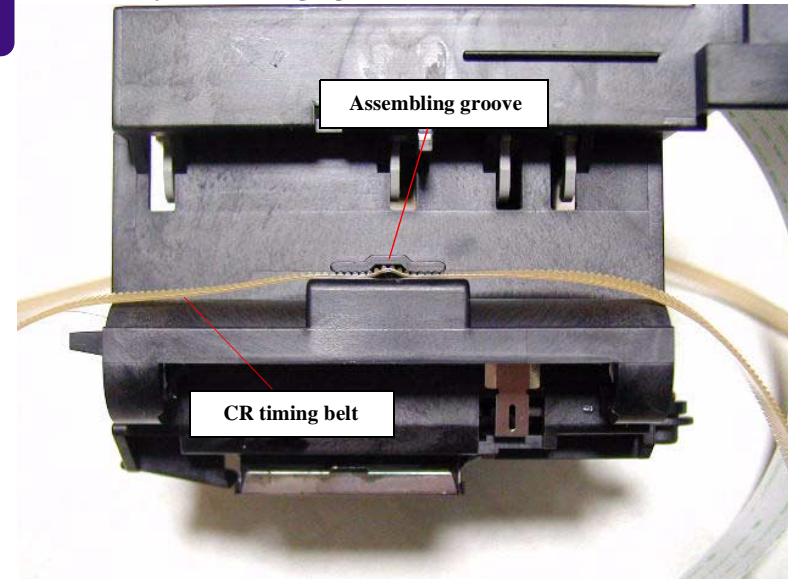

Figure 4-48. CR timing belt setting position



- When you replace the CR unit with a new one, lubricate it with the suitable amount of the G-55 grease by the specified position. Refer to Chapter 6 Figure 6-4.
- When you replace the CR Pulley shaft with new one, lubricate it with the suitable amount of G-26 grease by the specific position. Refer to Chapter 6 Figure 6-3.
- When removing or replacing the CR unit with a new one, adjust the Gap (Bi-d).

4.2.13 Paper feed roller removal

1. Remove the Housing from the printer. (Refer to Section 4.2.1.)
2. Remove the Paper Eject roller. (Refer to Section 4.2.10.)
3. Remove the CR unit. (Refer to Section 4.2.12.)
4. Release the PF grounding spring from the Main frame.

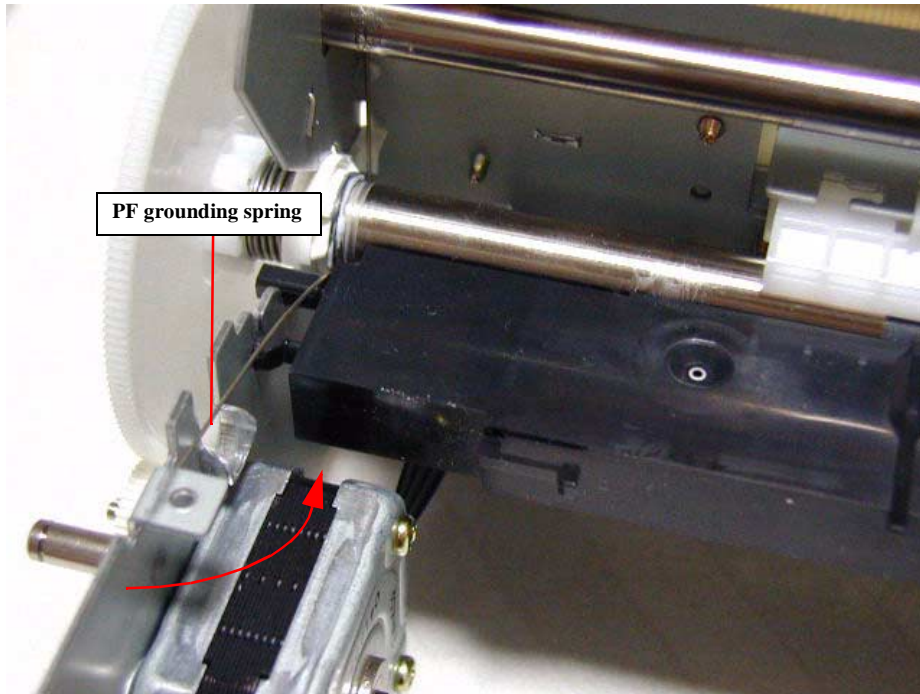

Figure 4-49. Releasing the PF grounding spring

5. Release one hook located on the right edge of the Front paper guide.

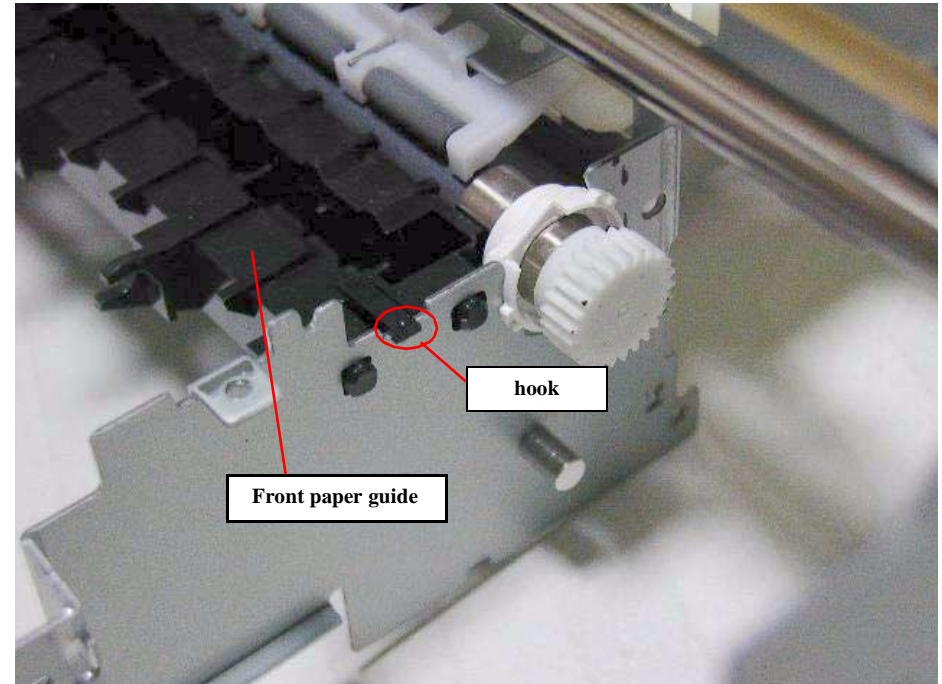

Figure 4-50. Release one hook of the Front paper guide

- Lift up the left edge of the Front paper guide while slanting the Front paper guide by pulling up its front edge, and then slide the Front paper guide to the left side after releasing the right hook on the Front paper guide.

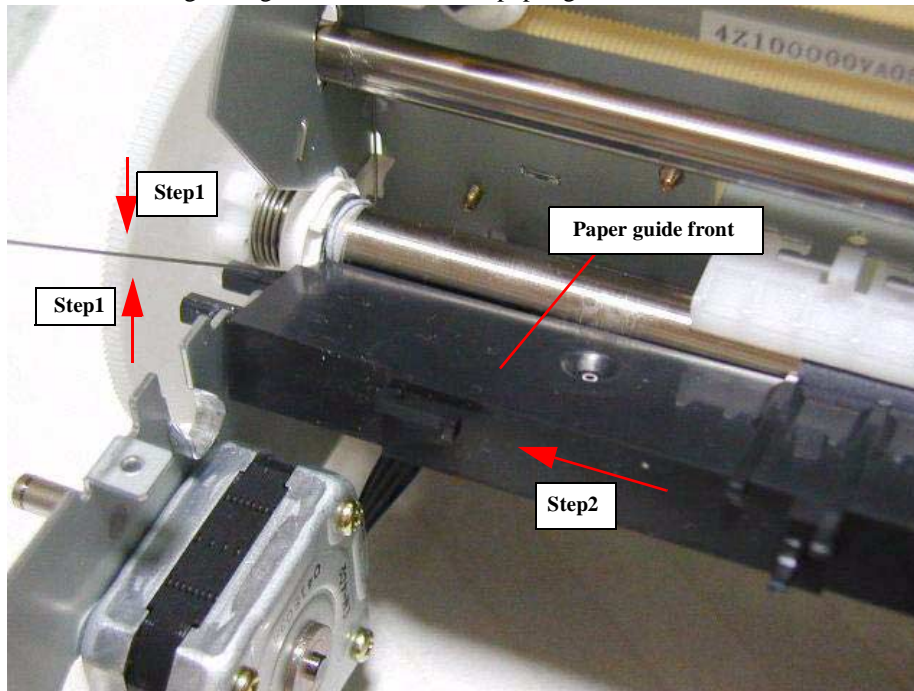

Figure 4-51. Remove the Front paper guide

- Fit the protrusions of the Left PF roller bushing to the notches in the frames as shown in the following figure and remove the PF roller fasten spacer with tweezers.

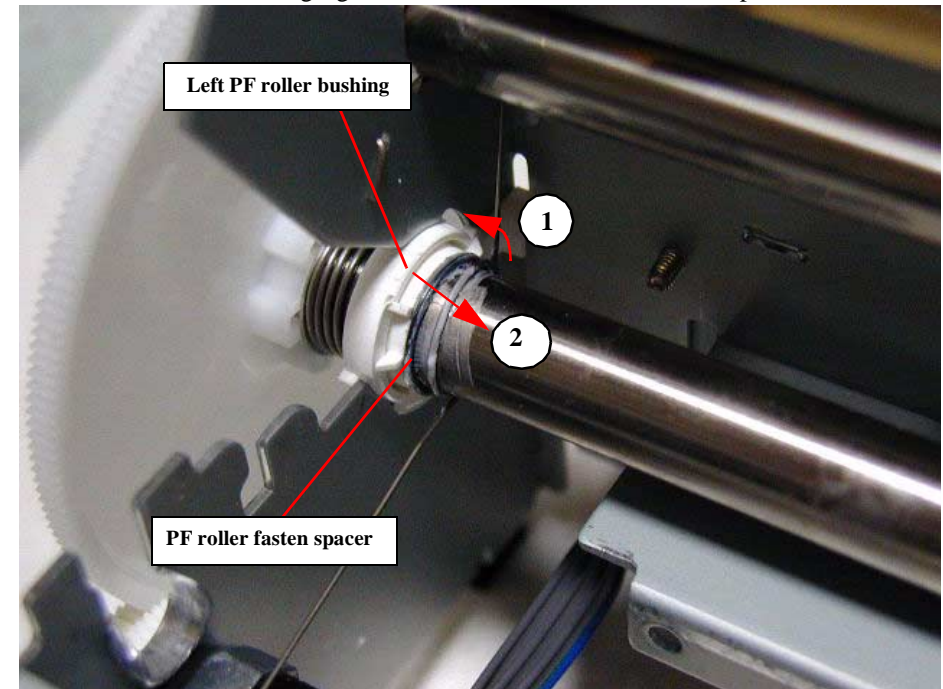

Figure 4-52.

Fit the protrusions of the Left PF roller bushing to each notches

- Slide the Left PF roller bushing to right side as above figure Step 2.

- Fit the protrusions of the Right PF roller bushing to the notches in the frames as shown in the following figure.

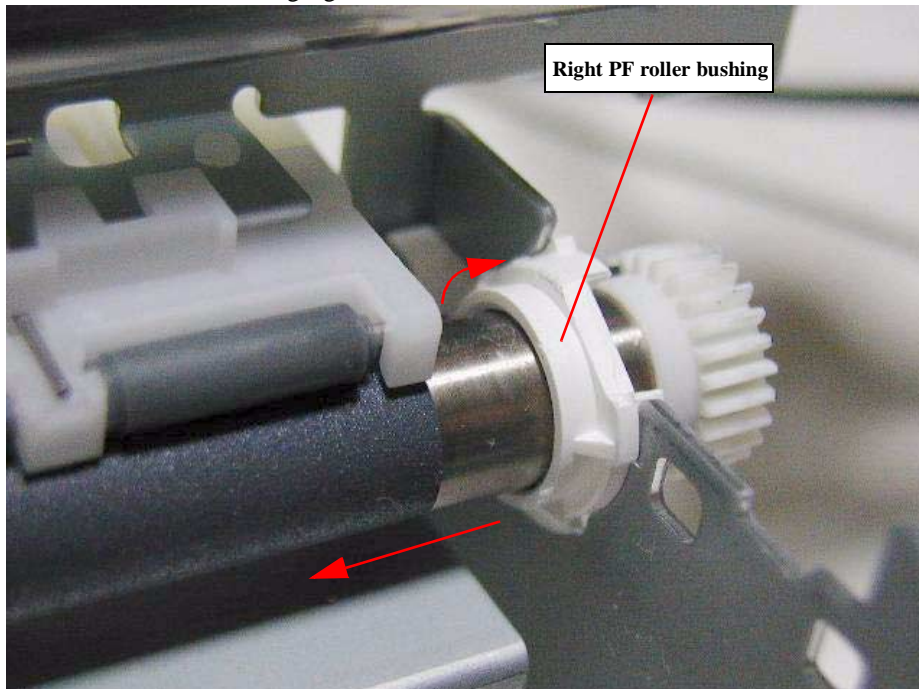

Figure 4-53. Fit the protrusions of the Left PF roller bushing to each notches

- Slide the PF roller to the left side along with the both PF roller bushings and remove the PF roller from the printer mechanism.



- After assemble the PF roller, make sure that the dowel of the both left and right PF roller bushing holder fit in the cut hole of both frames.
- After assemble the Front paper guide to the printer mechanism, make sure that the hooks and the dowel pins on the Front paper guide is set to the fitting positions secure. Slide the Front paper guide to the right side by pushing it and make sure that the right hook on the Front paper guide is locked to the frame securely. If the Front paper guide is not fixed securely to the suitable position, it may cause the paper jam problem.

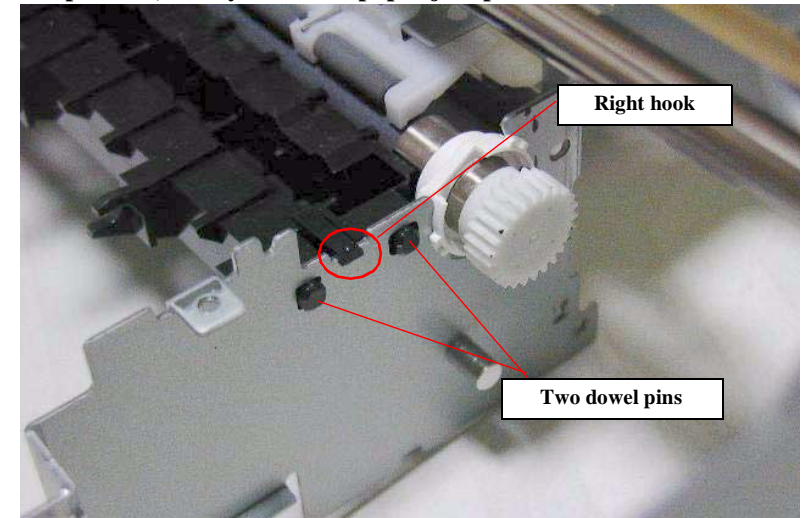

Figure 4-54. Front paper guide assembling notice



- When you replace the PF roller with new one, be sure to lubricate a specific amount of G-26 between the Left PF roller bushing holder and the left edge of the PF roller. Refer to Chapter 6 Figure.



- When you assemble the Front frame to the Printer mechanism, set the CR unit to the left side and assemble the Front frame from the right side. Be careful not damage the CR lock lever.

4.2.14 Disassembling ASF frame unit

1. Remove the Housing from the printer. (Refer to Section 4.2.1.)
2. Remove the LD roller shaft holder unit (Refer to Section 4.2.7.)
3. Remove two screws (C.B.S.-TITE (P4) 3x8, F/Zn screw, C.B.S.-TITE (P4) 3x6 F/Zn) securing the ASF frame unit and remove the ASF frame unit from the printer mechanism.

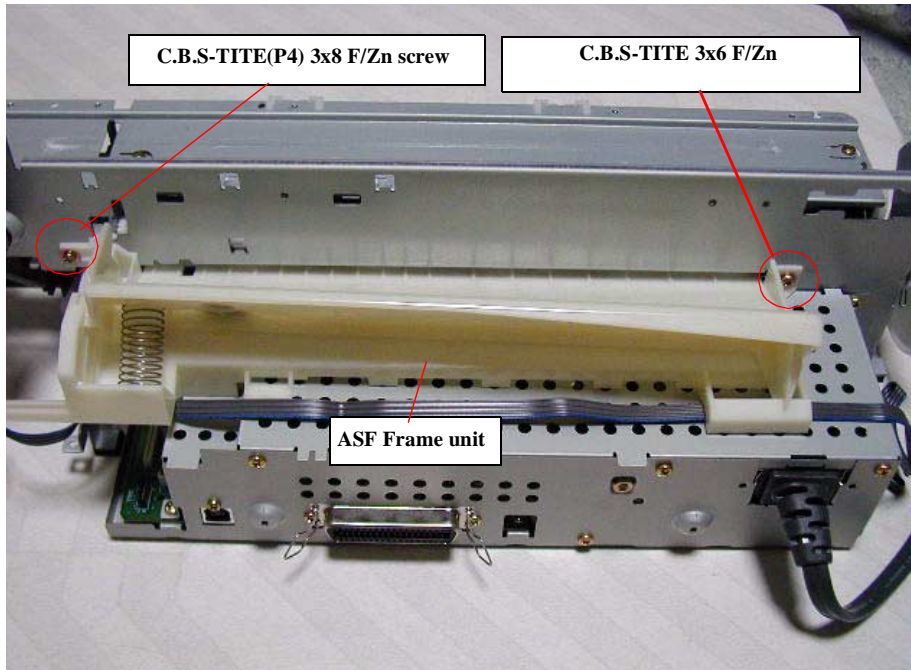

Figure 4-55. Removing the screws securing the ASF frame

4. Remove the Spur gear 23.2 from the ASF frame.

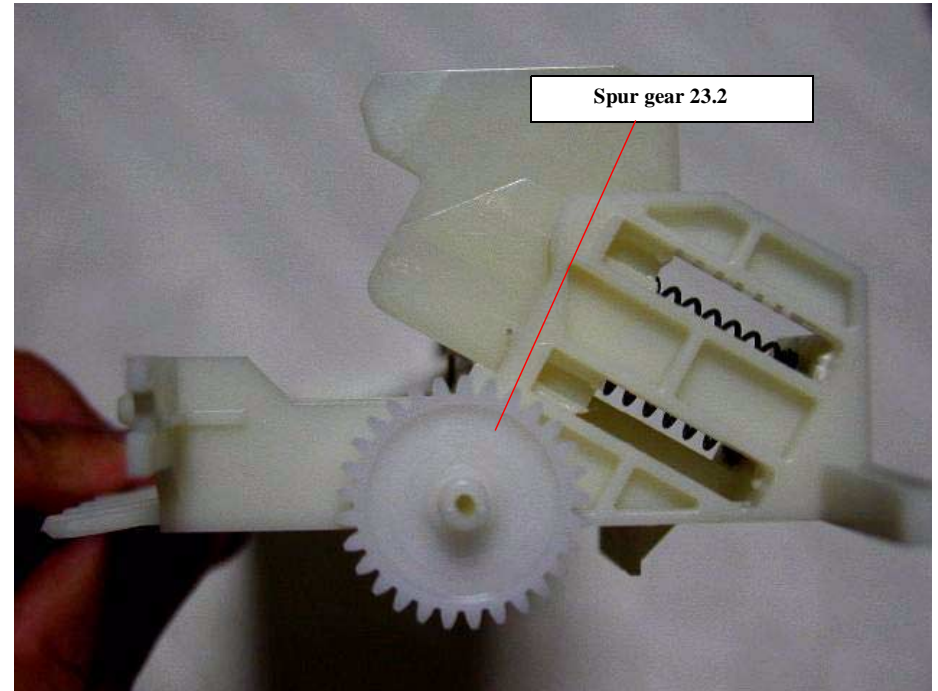

Figure 4-56. Removing the Gears from ASF frame unit

5. Remove the Compression Spring 2.67 located between the ASF Frame and the Hopper, and remove the Hopper from the ASF frame.

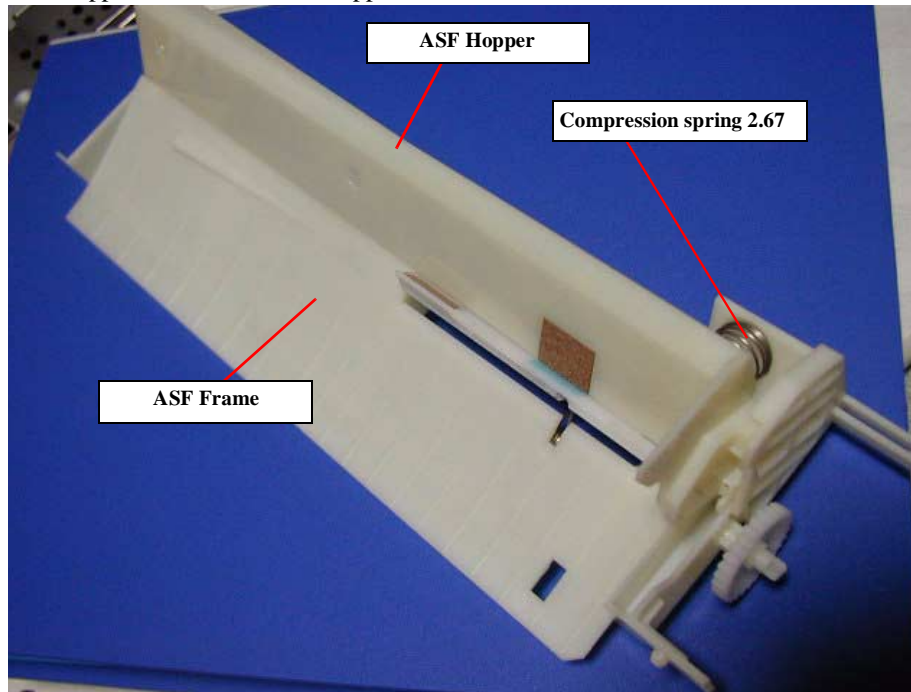

Figure 4-57. Removing the Compression spring 2.67

6. Remove the Torsion spring 25.7 from the bottom of the ASF frame and the Pad holder (Paper return plate).

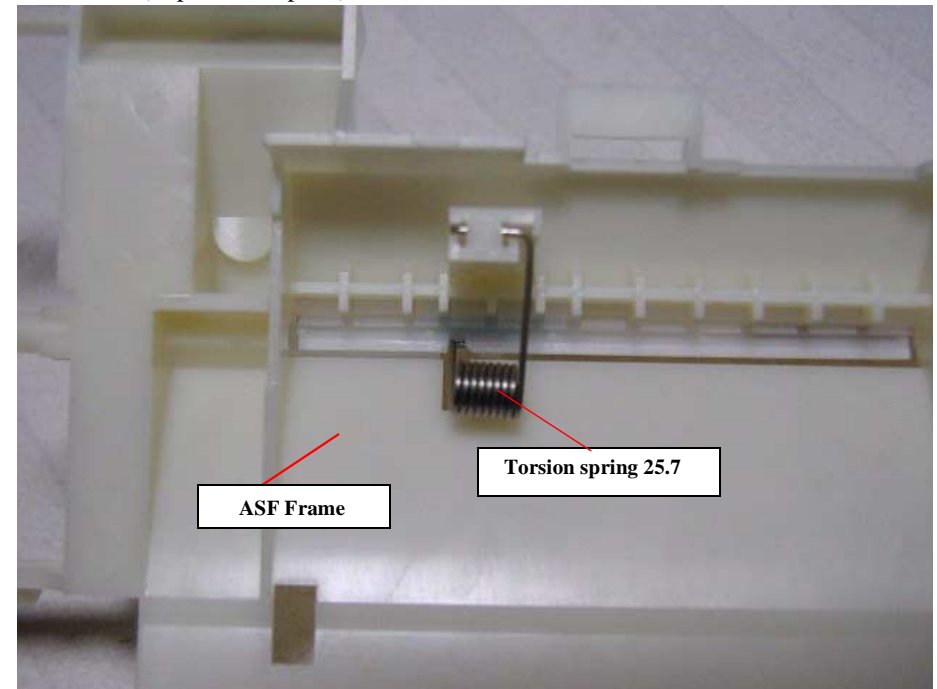

Figure 4-58. Removing the Torsion spring 25.7

7. Remove the Pad holder (Paper return plate) from the ASF frame.

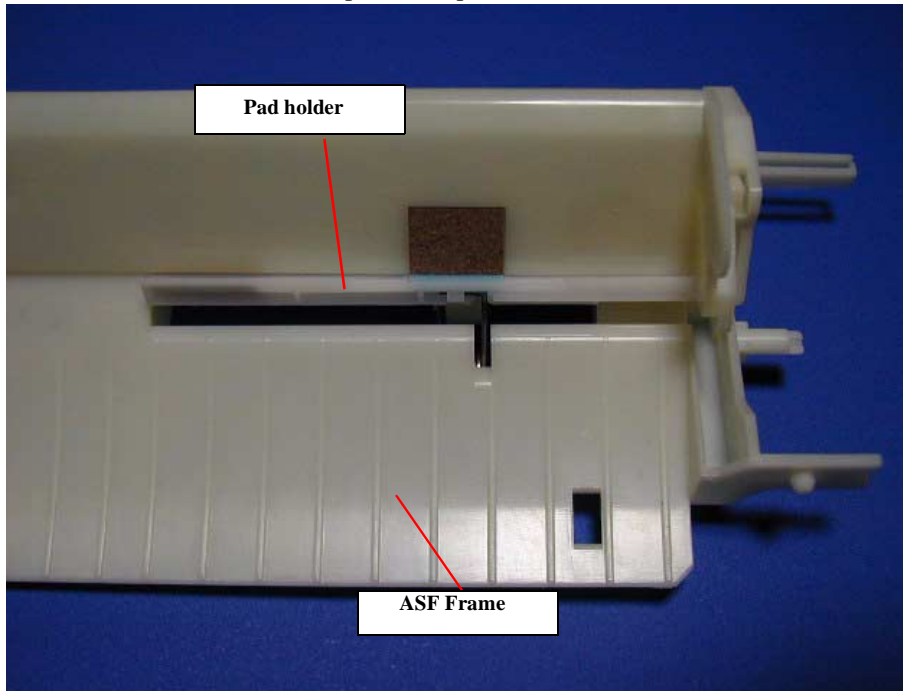

Figure 4-59. Removing the Pad holder (Paper return plate)



- Make sure that the each tip of the Torsion spring 25.7 is set in the slot of the Pad holder and ASF frame. Refer to Figure 4-57.
- Make sure that the Pad holder moves smoothly after assembling it to the ASF frame.



- When you replace the ASF frame or Hopper with the new one, make sure to lubricate the specific amount of G26 into the groove on ASF frame. Refer to Figure 6-2 Figure 6-3 & Figure 6-4 in the Chapter 6.
- Fasten the ASF unit C.B.S-TITE (P4) 3x8 F/Zn screw (left screw in the following figure), C.B.S-TITE 3x6 F/Zn screw (right screw in the following figure) in the order of following figure.

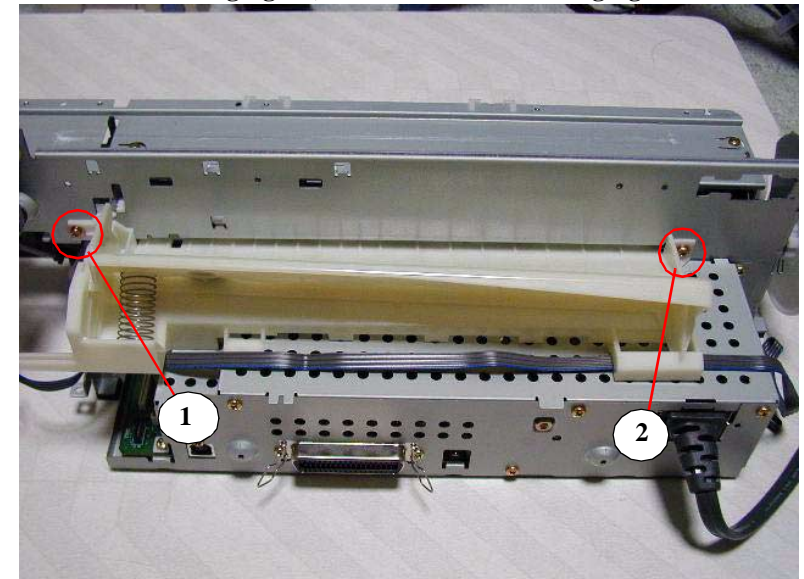

Figure 4-60. ASF fixing screws fastening order

- Tightening torque for screw
 - C.B.S-TITE (P4) 3x6 F/Zn screw for ASF (right screw in above figure) : 9+/-1 kgf.cm
 - C.B.S-TITE(P4) 3x8 F/Zn screw for ASF (left screw in above figure) : 9+/-1kgf.cm

CHAPTER

5

ADJUSTMENT

5.1 Overview

This section describes the procedure for adjustments required when the printer is disassembled and assembled for repair or service.

5.1.1 Required Adjustment

Table 5-1 lists all the necessary adjustments for this printer. If any service listed in this table is carried out, all adjustments corresponding to that service item should be performed to ensure proper operation of the printer.

Table 5-1. Required Adjustment

	1	2	3	4	5
Service item	Head ID input	Ink Change	Bi-D Adjustment	USB ID input	Protection Counter reset
Printhead removal	NA	NA	①	NA	NA
Printhead replacement	①	②	③	NA	NA
Main board replacement	①	NA	②	③	NA
CR Unit replacement or removal	NA	NA	①	NA	NA
CR Motor replacement	NA	NA	①	NA	NA
Printer mechanism replacement	①	②	③	NA	NA
Waste Ink pad replacement	NA	NA	NA	NA	①

NOTE: “O”: Required Adjustment. The number in the circle shows the required adjustment order.

“NA”: Not applicable.

NOTE: Following adjustments are not required on this product.

- Platen Gap adjustment
- Head Angular adjustment.

This section describes the detailed procedures of each adjustment by Adjustment Program.

In this printer, it is necessary to set the adjusting information for each printer mechanism in order to maintain consistent printing function and quality, eliminating differences of each printer mechanism’s characteristics. Therefore, in case that the combination of the printer mechanism and main board changes or the print head is replaced during the repair service, you must set and save the correct information to the MAIN board, using the exclusive adjustment program.

This section describes the detailed procedures of each adjustment by Adjustment Program.



In case any parts is removed and assembled on the repair product while running the Adjustment program, turn off the printer certainly.

5.1.2 Adjustment Program feature

This adjustment program is exclusive for Windows: the OS that allows operation of this program is Windows 98. The following shows programs included in this program.



- **This adjustment program operates only under Windows 98: This program does not operate under DOS or Windows 3.X, 95, NT.**
- **This adjustment program automatically install the appropriate program according to your OS.**
- **Perform this adjustment program using parallel I/F port or USB.**

The adjustment program enables you to set various values correctly to prevent malfunction and fluctuation of printing quality and printing function caused by difference in components and assembly when the printer components are replaced during repair. Basic adjustment items by using this program are shown as follows.

Table 5-2. Basic adjustment items

No.	Main Menu	Service
1	Adjustment	Head ID input
		Bi-D adjustment
		USB ID input
2	Maintenance items	Head cleaning
		Initial ink charge
		Refurbishment for DOA
		Protection counter check / reset
3	Check pattern printing	A4 check pattern print
4	Appendix	CSIC information
		EEPROM check / Write

The user interface of the main menu on this program is shown below.

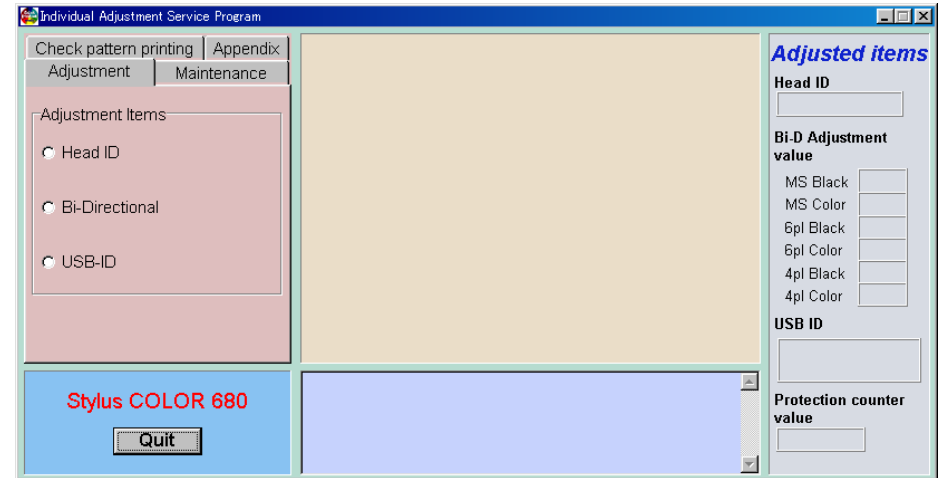

Figure 5-1. Adjustment program main menu

5.1.3 Adjustment Program Installation Procedure

This adjustment program is in the 3.5 2HD FD. The first FD is the installer disk. When you execute Setup.exe, the installation of the program will be started under Windows 98. After installation is completed, the Stylus COLOR 680/777/777i icon will be automatically made in the program menu. Go "Start" -> "Program" and click the icon to start this program.

5.1.4 Adjustment Program Initial Setting menu

You have to input the following four items before entering the adjustment main menu.

- Model name (Stylus COLOR 680/777/777i)
For the Stylus COLOR 777i, select Model name "Stylus COLOR 777."
- Interface setting (LPT1, LPT2, LPT3, EPUSB1, EPUSB2, EPUSB3)
- Destination (EURO / ASIA, EAI)

Follow the procedure below to input the initial settings.

1. When you run this program, the following menu appears. Select the Stylus COLOR 680 or 777/777i in the screen below.

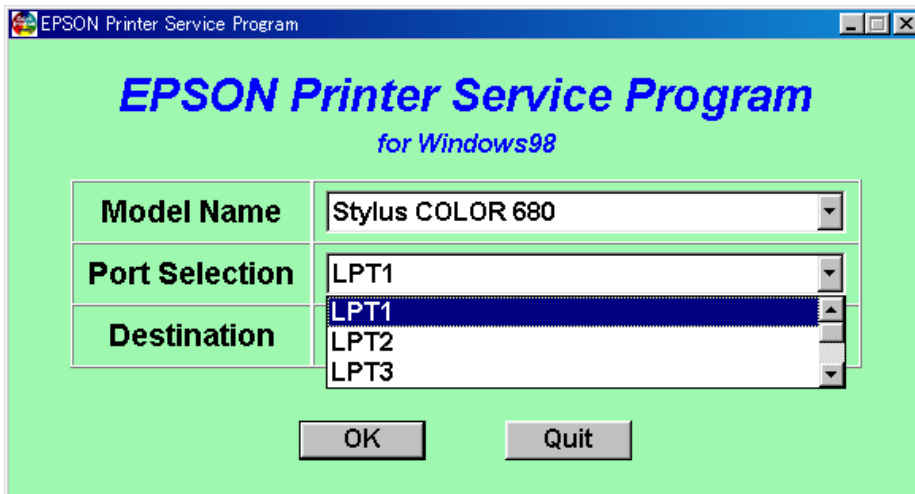

Figure 5-2. Model Name Selection

NOTE: This printer stores model name in the PROM. Therefore, even you select the model name in the screen above, model name will not stored in the EEPROM. Selecting model name in the screen above determines respective special command for each model.

2. Select the Interface port number which you connect the printer to your PC as above Figure 5-2.
3. Select the suitable destination in the Destination menu.

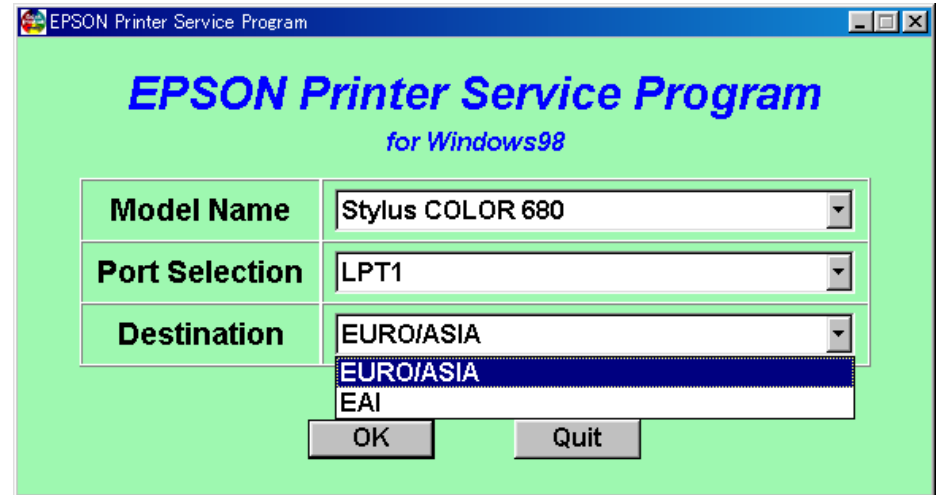

Figure 5-3. Destination Setting

5.1.5 Head ID Input

This adjustment function is required when any of the following parts is replaced.

- Printhead
- Main board
- Printer mechanism

This adjustment function enables you to write printhead ID into the specific address of the EEPROM. This operation is considered the most important to maintain proper ink discharging system. If any ID is not written correctly, it results in white or color lines and also gives bad influence on dot weight.



Before or after performing this operation, refer to the table 5-1 and perform any appropriate adjustments or operations.

1. Run the Adjustment program and enter the Adjustment Main menu.
2. Choose the “Head ID” and click it.
The menu shown in the next page appears. This function is useful only when the Main board is replaced with new one. When the print head is replaced with new one, go to step 5.

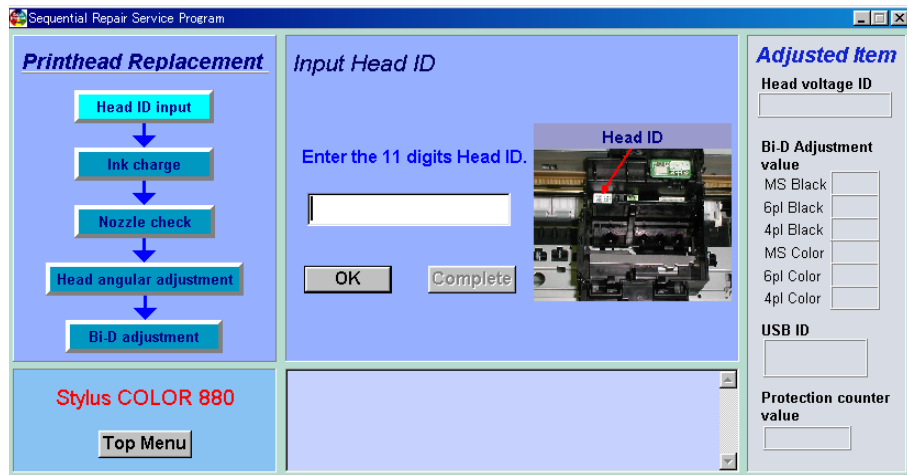

Figure 5-4. 1st Head ID adjustment items menu

3. If you replace the failure Main board with a new one, try to perform the “Check head ID”. In case the logic circuit dose not have any damage, you can read out the Head data of the present Head ID data. If this function is available, you can check the present Head ID without removing the Head FFC holder.

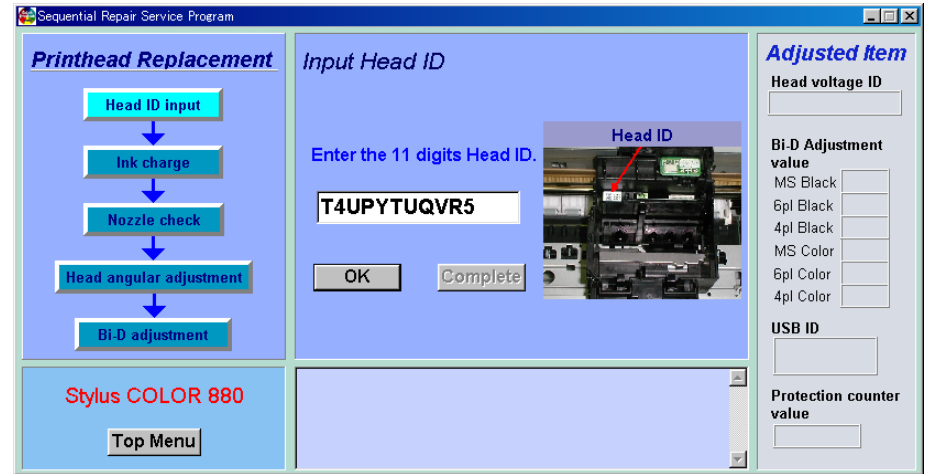

Figure 5-5. Read out the Head ID from the EEPROM

4. If you can read out the present Head voltage ID, take memo the read out Head ID voltage.

NOTE: In this Adjustment program, you can not write the read out Head ID to the new Main board in the read out Head ID menu. In case you write the read out Head ID to the new main board, you have to take menu the read out Head ID and input it again in the “Input head menu.”

- Choose the "Input head ID" item in the Head ID menu and click the OK button. Following Head ID input menu is displayed.

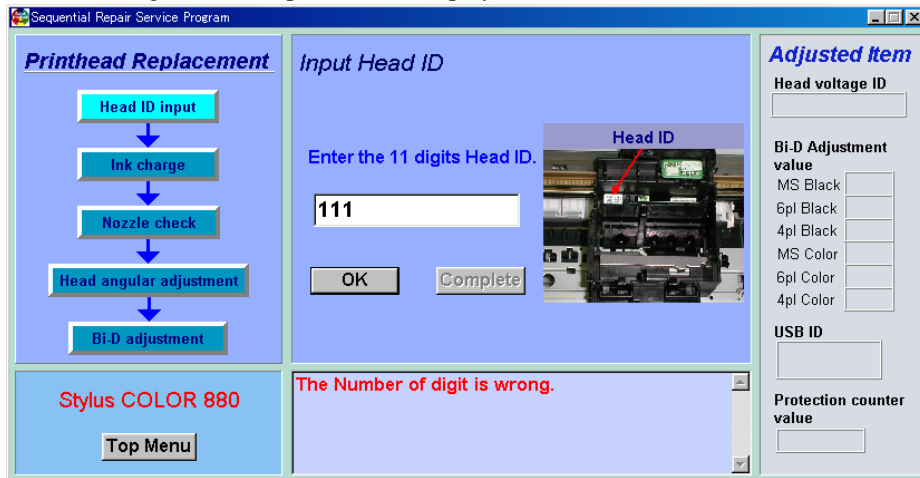

Figure 5-6. Entering the 11 digits Head ID

- Input a 11-digit code of the Head ID in the above menu. In case you input the incorrect character or symbol in this menu, this program detects it automatically and displays error message in the bottom column. Figure 5 shows you the one of the error message.

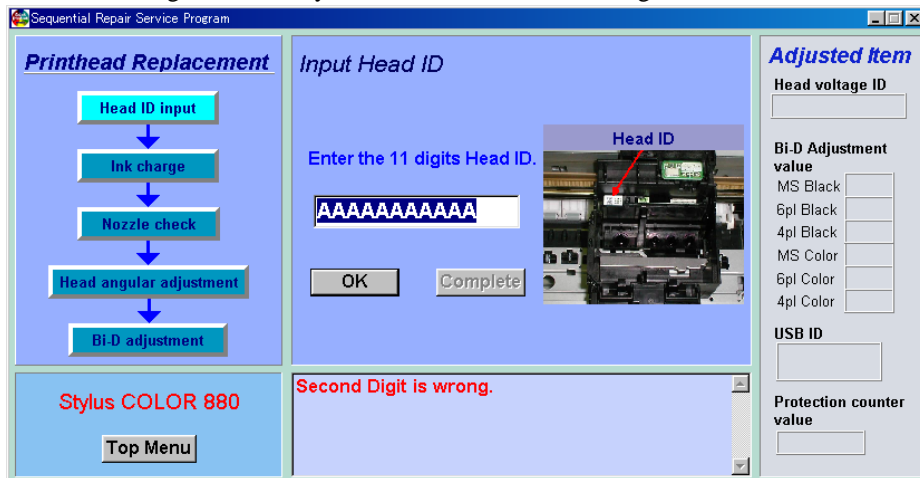

Figure 5-7. Error message in the Input head ID menu

- When the Head ID is input and write to the EEPROM, the following message is displayed on the bottom column in the menu.

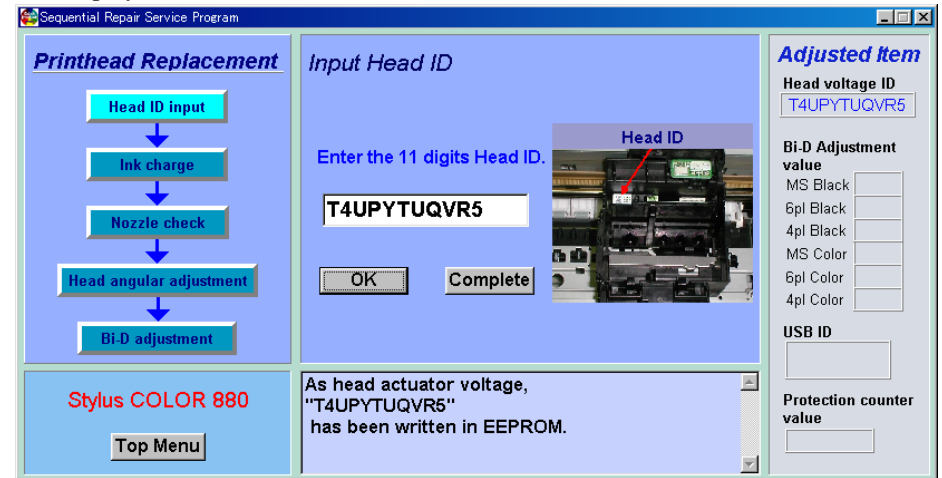

Figure 5-8. Completing the Head ID input

5.1.6 Bi-D Adjustment

You perform this adjustment to correct differences in printing positions, which is caused by incorrect of printing timing in right and left directions during the Bi-directional printing. Therefore, you are required to perform this adjustment after performing the following operations.

- Replacing the Print mechanism
- Replacing the main board
- Replacing the CR motor
- Replacing the Carriage Assembly
- Replacing the Prinzzthead

1. Choose the “Bi-directional” in the “Adjustment main menu” as following figure.

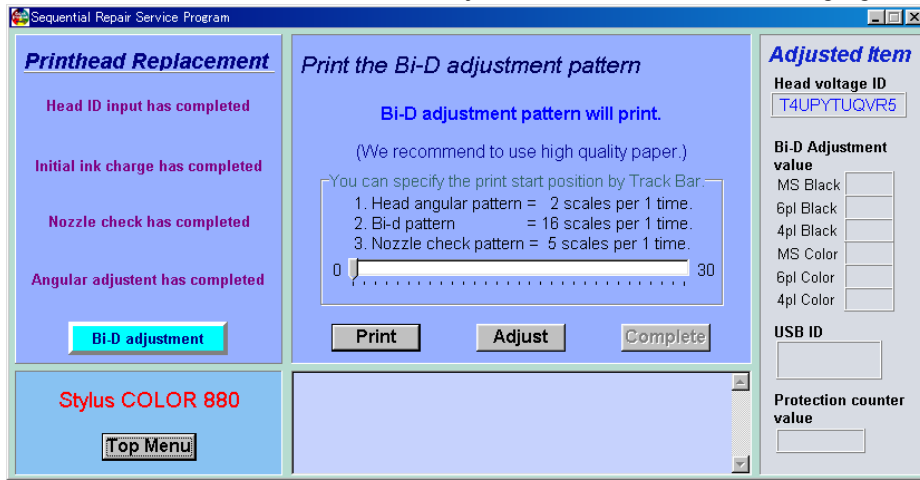

Figure 5-9. Choose the Bi-d adjustment

2. Choose the “Print the Bi-d adjustment pattern” in the “Bi-Directional Adjustment pattern” and click the “OK” button.

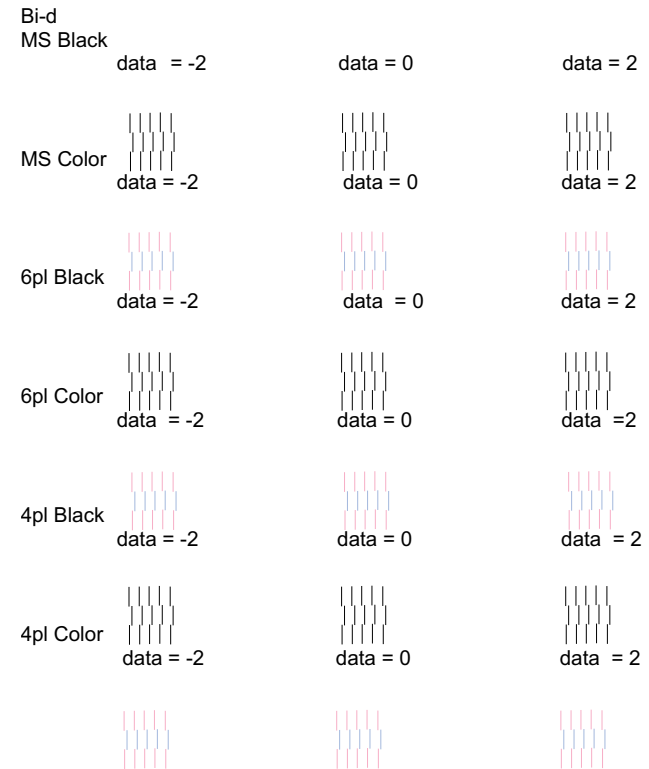

Figure 5-10. Bi-d adjustment pattern.

NOTE: As shown in the sample, gaps between passes are sometimes created in different directions among patterns.

This unexpected change in direction is caused by an ink jet printer-specific reason, which is an ink jet printer inevitably performs a periodical cleaning specified by the flashing timer even during Bi-D pattern printing, so that the printing direction suddenly changes.

However, this directional difference among Bi-D patterns should not be considered, and you can always confirm and adjust the pattern correctly by referring to gap amount only.

- Click the “Previous” and go back to the Bi-Directional adjustment items” menu. And choose the “Input Bi-D adjustment value” menu and click the “OK” button.

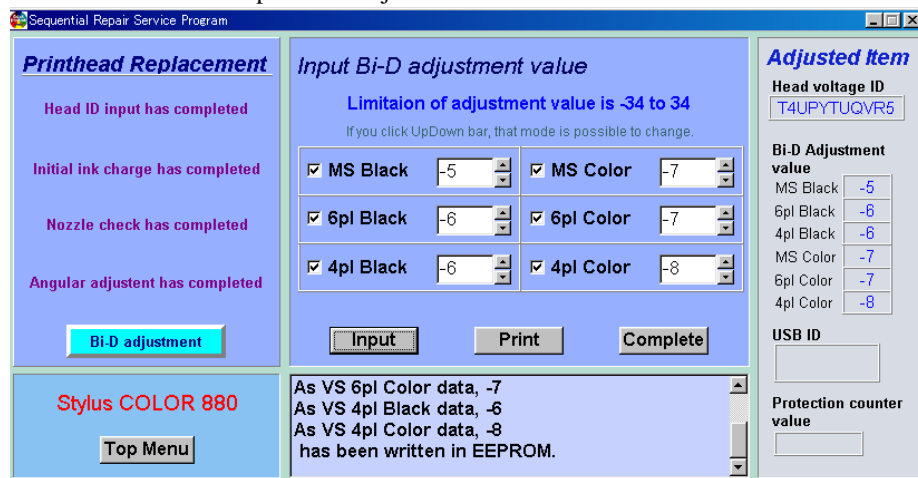

Figure 5-11. Choose the Adjust menu

- Check the printed pattern. Choose the misaligned dot size and Input the suitable value in the menu and click the “OK” button. The input value is written in the specific address of the EEPROM. Refer to Figure 5-12. The value 0 (blue) appears in the center of the screen and changes the value by clicking the up/down icon. Apply the value for the most properly aligned pattern in the Bi-D adjustment pattern print. You can change the value by input the suitable value directly from the key board. In case the + value is input, the 2nd vertical printed pattern is shift to the left side. And in case the - value is input, the 2nd vertical printed pattern is shift to the right side.

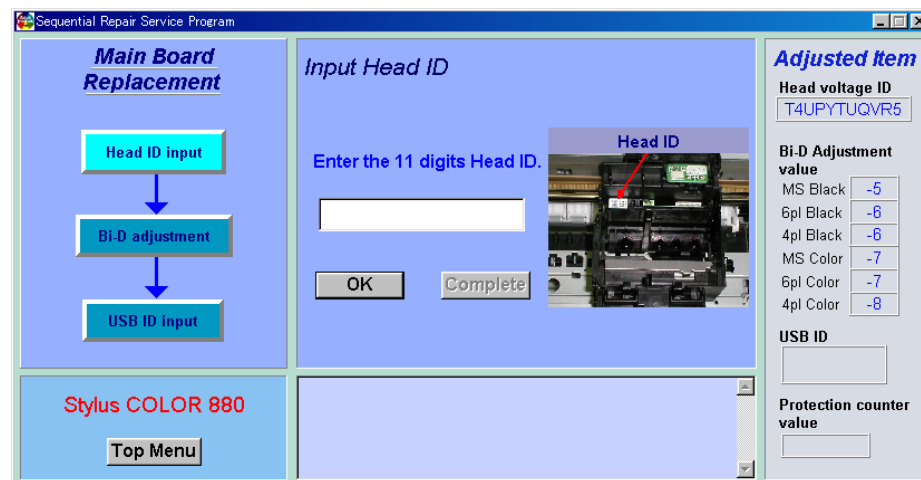

Figure 5-12. Input the suitable value

- To confirm if the adjustment value is suitable, click the “Previous” button and go back to the “Bi-Directional adjustment items” menu.
- Choose the “Print the Bi-D adjustment patter” and click the “OK” button.
- Check if the all 3 vertical line is alined correctly in the adjusted dot size pattern. If you can watch the misaligned pattern, repeat the step 3 to Step10 until the Bi-d adjustment pattern is alined.

5.1.7 USB ID input

When you replace the main board with a new one, you have to input the USB ID newly into the specific address of the EEPROM.

When the Printer and the PC are connected with a USB cable, the USB port driver loads the unique code from the specific address of the printer’s EEPROM and the provides the USB port number to the unique code. The USB port driver controls the several USB ports under the Windows 98 environment.

A unique code called USB ID is input to the specific address of the EEPROM in our manufactory and the following total 18-digit code is used as a USB ID for the EPSON ink jet printer.

- Factory line number (3-digit)
- PC number (2-digit)
- Input year/month/date/time (hour,minutes,second) (12-digit)
The timer data of the PC is used for this input data.
- Number 0
An "0" is automatically added for the last digit in the input program.

In repair activity, we use a 10-digit code of the Serial number for a USB ID. The remaining 8digits code is generated in the adjustment program and added to the serial number automatically.



In case the USB ID is not input in the adjustment program after the main board is replaced to new one, the USB ID may not possibly unique one. In this case, the USB ID conflicts the another peripheral USB ID in the USB port driver and the another USB peripheral may not possibly be used with the USB.

1. Choose the "USB ID input" in the Adjustment main menu.

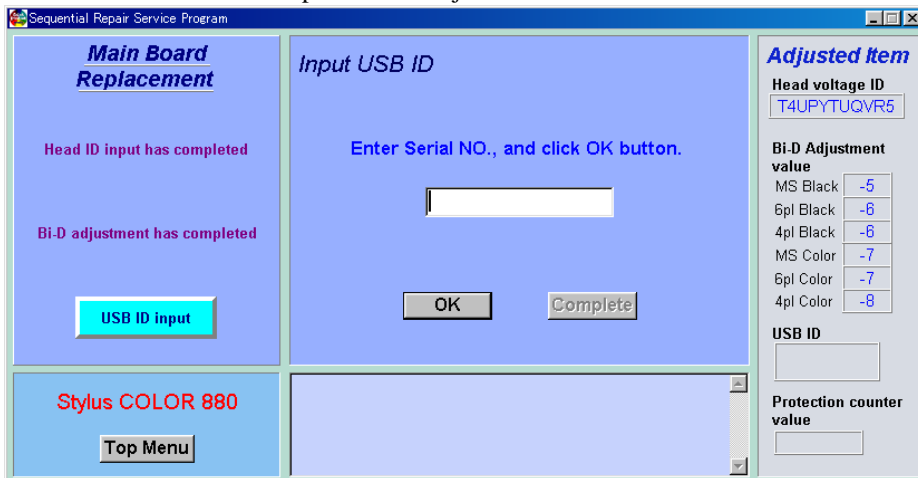

Figure 5-13. Choose the USB ID input menu

2. Choose the "Input USB ID" and click "OK" button in the "USB ID check/Input" menu. Following menu is displayed.

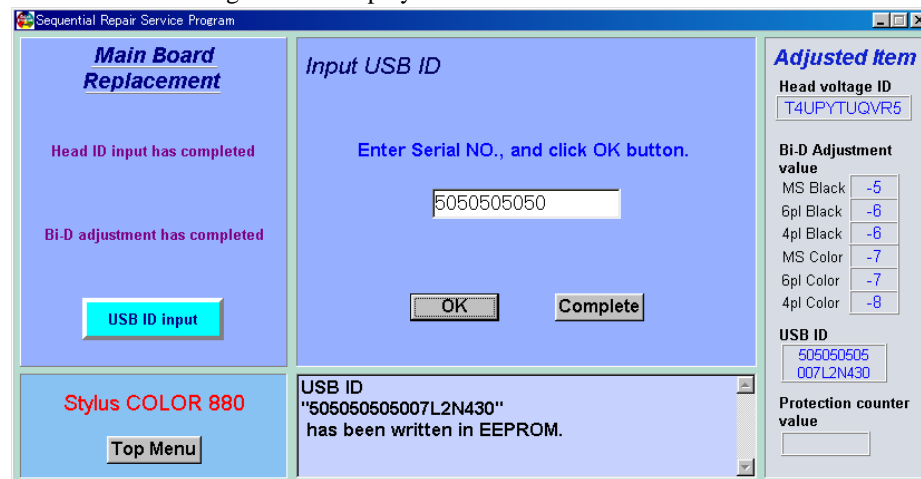

Figure 5-14. Choose the USB ID input menu

3. Check the 10digits code of the serial number on the serial number label stuck around the rear side of the Upper housing.
4. Input the 10digits code of the serial number in the input menu and click "OK" button.

NOTE: Even though you input irresponsible another 10digits code and click the "OK" button, the program allow to input the code and write down it the specific address of the EEPROM. But, there is a possibility that the code is not unique and the code conflicts another USB ID in the USB port driver.

- After click the “OK” button, following message is shown in the bottom of the USB ID Check/Input menu In this message, you can check if the USB ID is written in the EEPROM correctly.

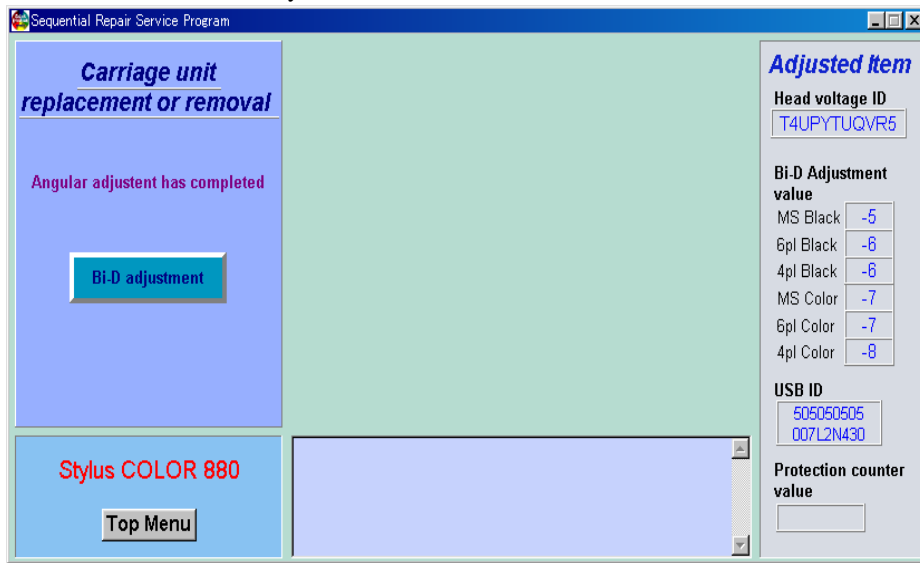

Figure 5-15. Write down the USB ID

5.1.8 Head Cleaning Operation

With this sequence, you can forcibly solve the clogged nozzle problem caused by viscous ink. This program performs powerful cleanig forcibly.



If you can not recover the clogged nozzles despite you performed this cleaning operation, enter the Initial ink charge sequence by referring to Section 5.1.9.

- Choose the “Head cleaning” in the “Maintenance menu” as following figure.

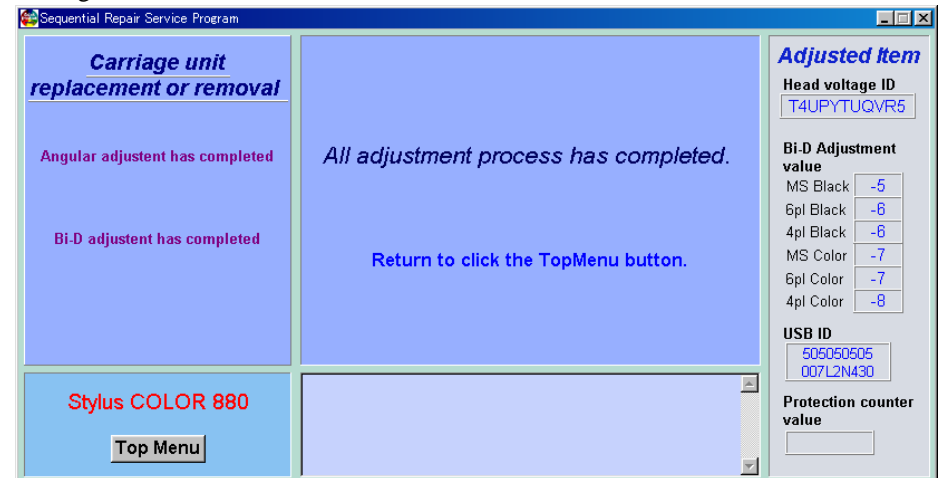

Figure 5-16. Choose the Maintenance menu

- Click the “OK” button in the menu. The powerful cleaning is performed. (It takes 30 seconds for the process to complete.)

5.1.9 Initial Ink Charge Operation

After you replaced any of the following units, perform initial ink charge and return the printer after making sure that ink is ejected correctly from the printhead.

- After replacing the printer mechanism
- After replacing or removing the printhead

CAUTION Before you perform the initial ink charge operation, replace the installed cartridges with new ones, because the ink amount used for the initial ink charge operation is so large.

1. Choose the “Maintenance menu”. The following menu is displayed.

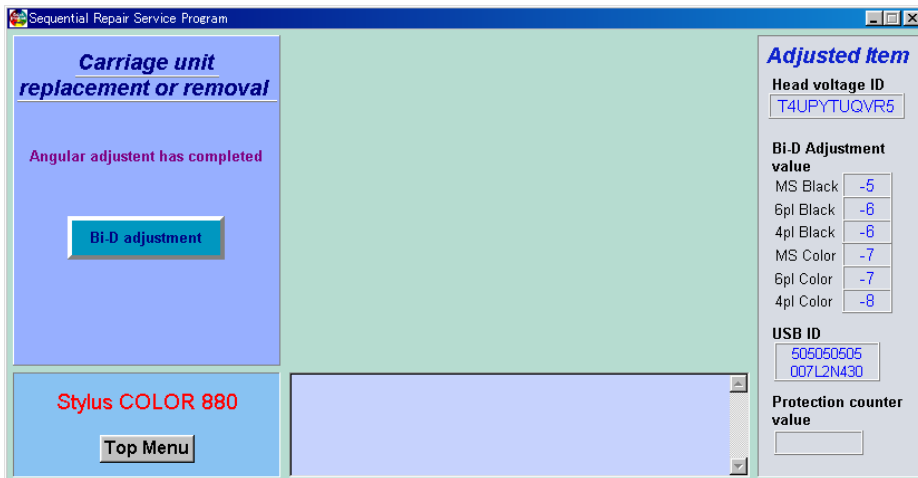

Figure 5-17. Choose the Maintenance menu

2. Choose the “Initial Ink charge” item in the “Maintenance Menu” and click the “OK” button.

NOTE: As described in the menu message, about 1/9 amount of the Black ink cartridge and 1/6 amount of the Color ink cartridge are consumed in the initial ink charge operation.

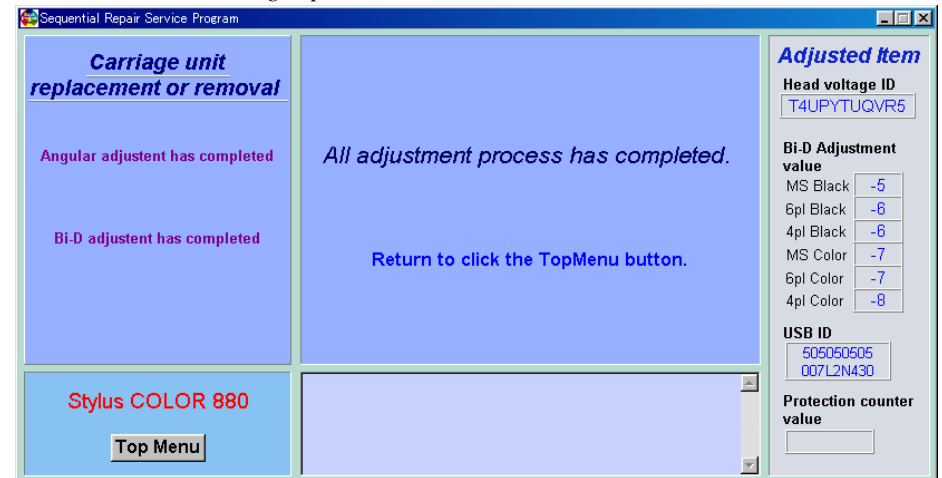

Figure 5-18. Choose the Initial Ink Charge

NOTE: The initial ink charge is carried out without turning off/on the printer. It takes about 1 minutes & 45seconds for this operation to complete the whole sequence.)

5.1.10 Refurbishment for DOA

If you clean the cavity of the printhead and cap assembly, this function will be useful.



- After carry out this function, replace the waste drain ink pad with new one and reset the Waste drain ink pad counter. Otherwise, the ink or S46 liquid may leak from the pad during the transportation.
- Prepare the following tool.
 - * Dummy ink cartridge, Injector, S46 liquid
- Do not carry out this program (Exchange sequence 1&2) repeatedly. **This operation is available only one time.** Excessive operation causes overflow of the ink& S46 liquid.
- When you refurbish the repair product by using this program, do it on your responsibility.
- When you charge S46 liquid into the dummy ink cartridge with the Injector, make sure fill out the dummy ink cartridge with S46 liquid. In case enough S46 liquid is not charged into the dummy cartridge, the printhead will not cleaned and not filled with the S46 liquid enough in this operation.
- Keep the S46 liquid and the dummy ink cartridge clean.

1. Select the “Refurbishment for DOA” function in the Maintenance menu. The main menu of this function is as following figure.

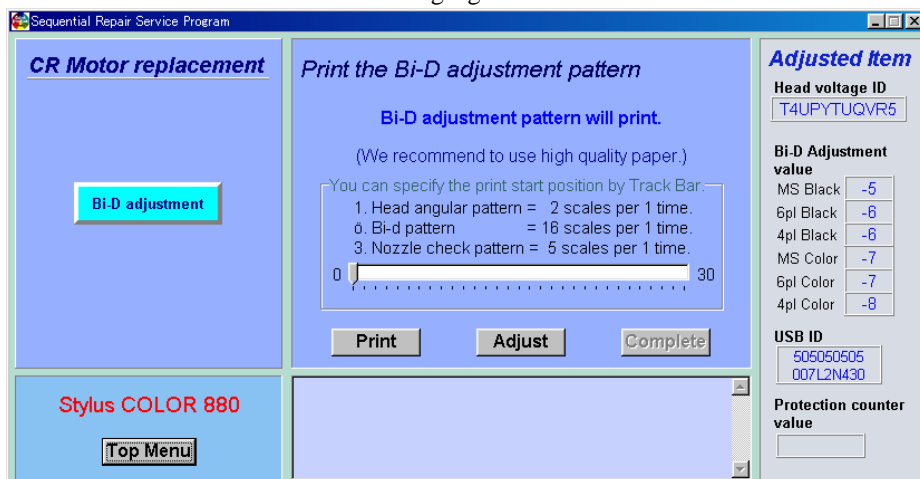

Figure 5-19. Refurbishment for DOA

2. Click the “EXCHANGE SEQUENCE” in the Transportation Liquid Exchange menu.

- Exchange sequence 1

Set the dummy I/C filled with S46 liquid into the CR unit and press the “Error reset switch” in the printer’s control panel. The S46 liquid is charged into the printhead cavity and ink is discharged from printhead cavity to the cap.
- Exchange Sequence 2

Remove the dummy I/C from the CR unit and press the “Error reset switch SEQUENCE2” in the printer’s control panel. In this sequence, the S46 liquid is not discharged from the printhead and only the ink in the cap is discharged to the waste drain ink pad. After complete this sequence, this program set the initial ink charge flag into the EEPROM and reset the several ink consumption counters to “0”.

5.1.11 Protection Counter Check/Reset

The program allows you to check or clear the current protection counter value. (waste ink amount counter)

You can confirm or clear the current protection value by main unit alone. Refer to Section 1.4.3.)

NOTE: You can confirm or clear the current protection value by main unit alone. Refer to section 1.4.3

[Check the present counter value]

1. Choose the “Check the present counter” in the “Maintenance “menu and click the “OK” button.

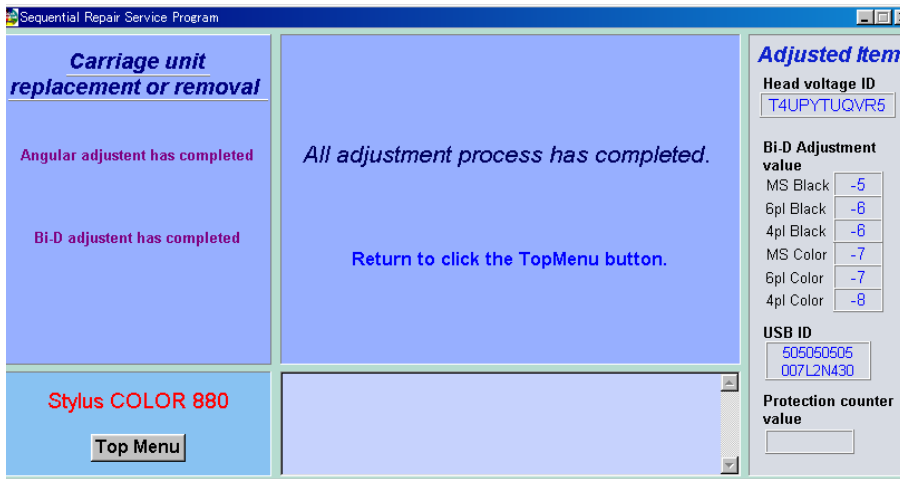

Figure 5-20. Choose the Check the present counter

2. By clicking the “OK” button, following menu is displayed.

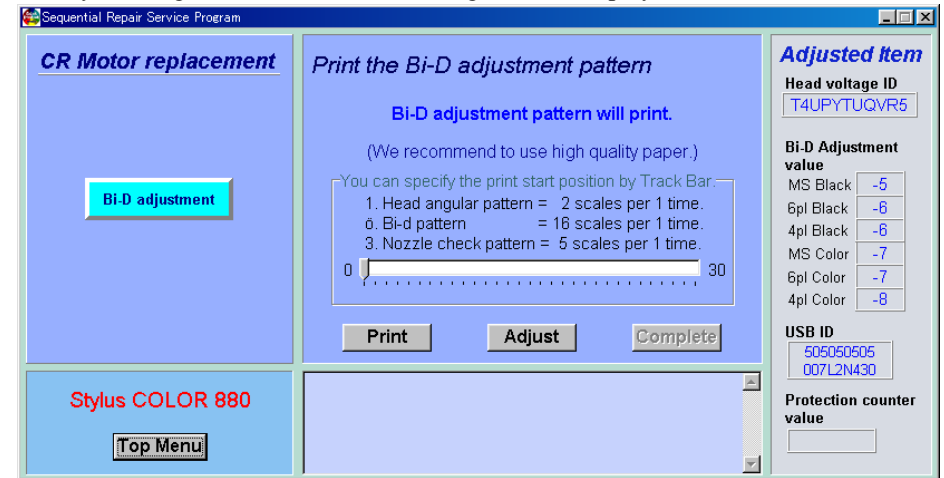

Figure 5-21. Check the present counter

3. After read the Caution description on the above menu, click the “OK” button in the menu. The present counter value is displayed on the bottom column as following figure.

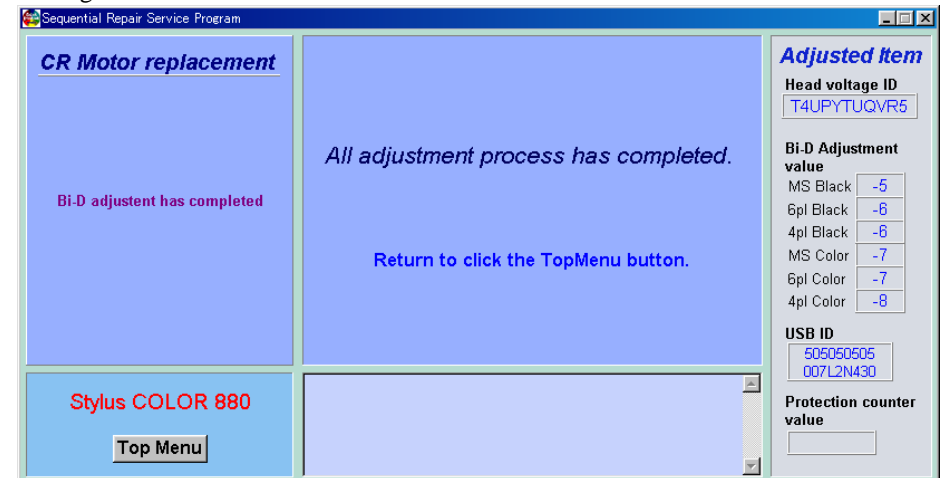

Figure 5-22. Present counter value

- If the present counter value is over 24200 points, we recommend you to replace the Waste ink drain pad to new one.

[Clear the protection counter value]

- Choose the “Clear the protection counter value” in the “Maintenance” menu and click the “OK” button.

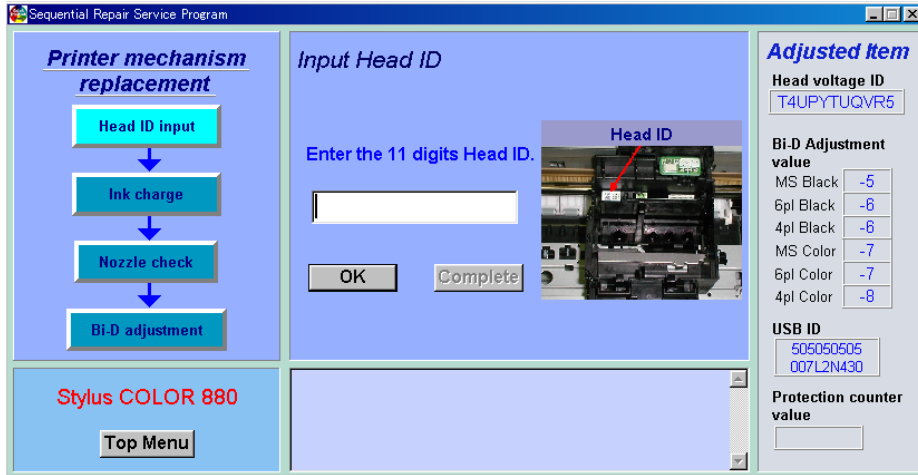

Figure 5-23. Choose the Clear the protection counter

- By clicking the “OK” button, the following menu is displayed.

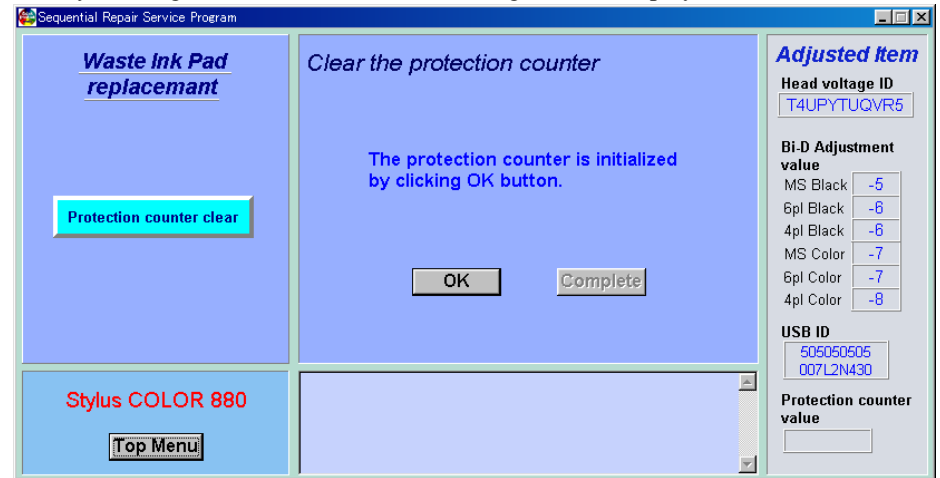

Figure 5-24. Clear the Protection counter

- Click the “OK” button. When the “OK” button is clicked, the following message is displayed. Click “Yes” button clears the counter in the EEPROM.



Figure 5-25. Warning message



- Be sure to replace the installed waste ink pad with a new one after or before you clear the current protection counter value.

5.1.12 Check pattern printing

This function prints following several kinds of the check pattern on the A4 paper. By printing this A4 pattern, you can check the all adjustment result on the printed result.

NOTE: 2 sheets of the A4 Plain paper is used for this printing. So, set 2 sheets in the ASF unit before starting the program.

1. Choose the “Check pattern printing” and click the “OK” button to print the A4 check pattern in the following menu.

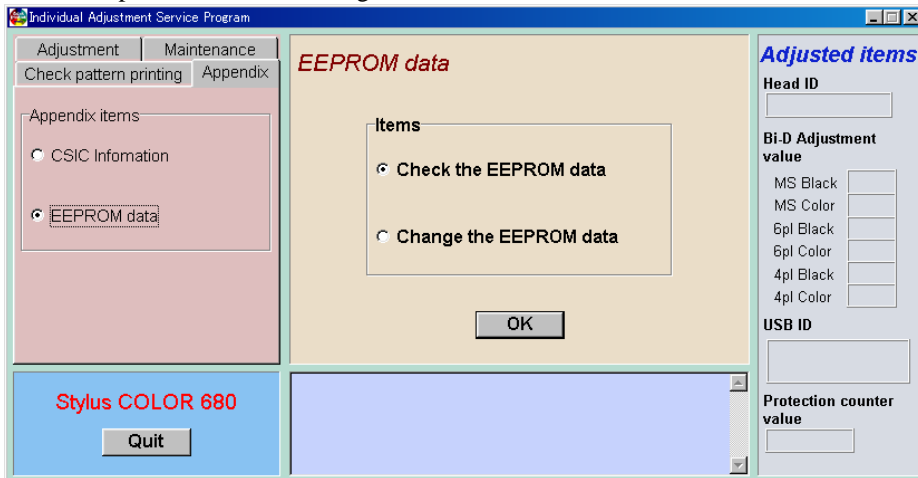

Figure 5-26. Choose the Check pattern printing

2. After complete the printing, following message is displayed on the bottom column in the menu.

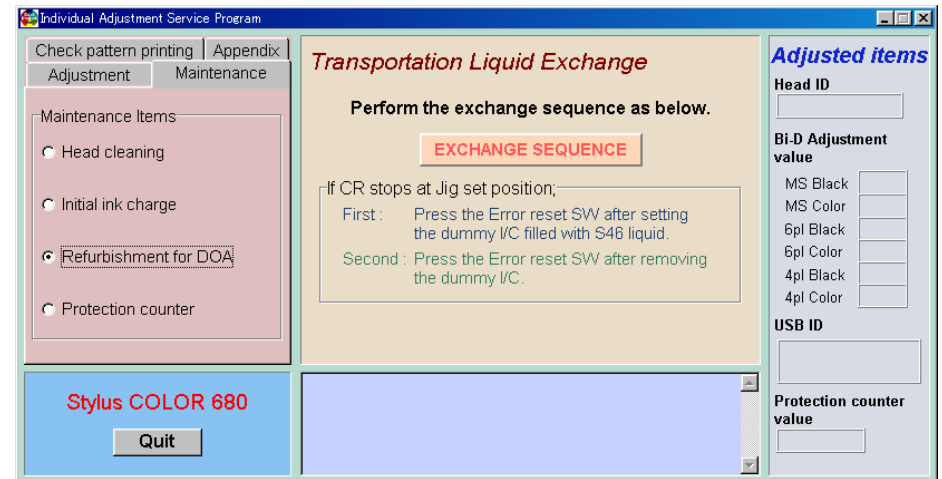

Figure 5-27. Complete the printing

3. Check the all printed patterns on the 2 sheets of the printed paper. If you find out any incorrect portion, Choose the adjustment menu and try to adjust it.



- The check point for the first solid pattern (beta pattern 360 x 360dpi normal dot) in the A4 Check pattern is as follows.
 - Any white line is not observed
 - Uneven banding is not observed extremely.
- The check point for the second Nozzle check pattern (360dpi) is as follows.
 - Ink is fired from all nozzles.
 - Uneven banding is not observed extremely.

5.1.13 EEPROM check function

You can check the EEPROM data or can write the specific data into the specific address of the EEPROM directly even if the printer is error condition. (In case one of the main logic circuit such as CPU, I/F receiver IC, RAM, EEPROM is broken, this function is not available)

Select the “EEPROM check” function in the Maintenance menu. The main menu of this function is as following figure. The following two function is built in this program.

- Check the EEPROM data
You can check the specific data stored in the specific address of the EEPROM.
Input the specific address with hexadecimal code by referring Section 7.1.2 on page 127 (EEPROM map). Use this function in your analysis usefully.

- Change EEPROM data
You can change the specific data stored in the specific address of the EEPROM.
However, do not use this function except the special case. Careless usage causes any trouble.

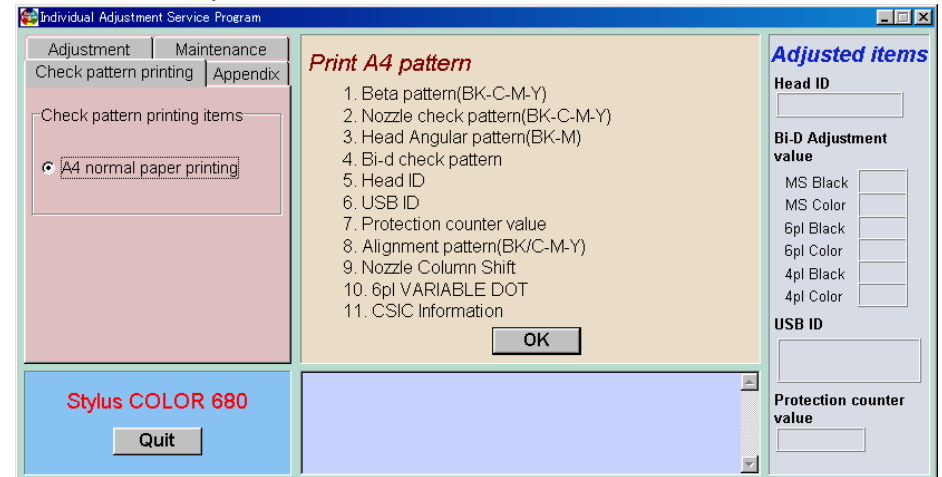

Figure 5-28. EEPROM data



- Do not use this function except the special case. Careless usage causes any trouble.

5.1.14 CSIC Information

CSIC is an EEPROM mounted on both black and color ink cartridges. Data on the ink's life expectancy and other information is logged within the EEPROM.

The ink's life expectancy based on this data is displayed on the print driver's status window.

1. Start up the adjustment program to display the main menu screen.
2. Select "Appendix" from the main menu.
3. Select "CSIC Information" to display the CSIC information window.

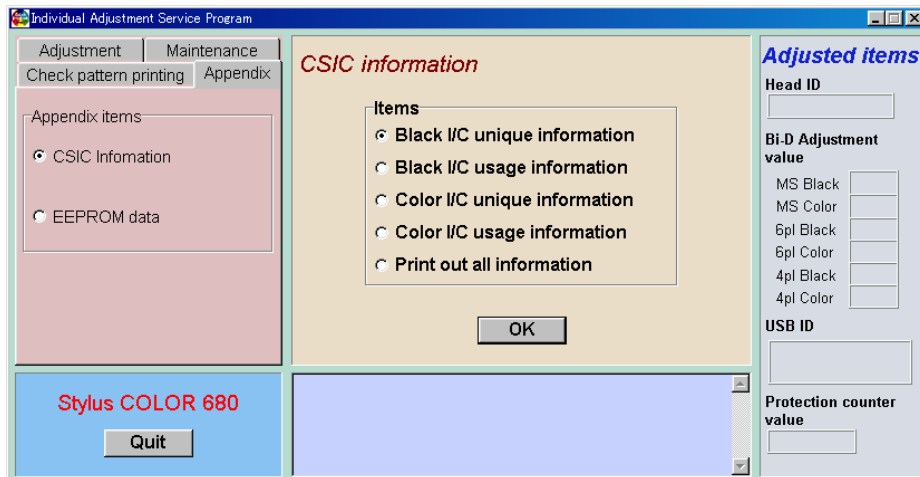

Figure 5-29. CSIC Information

4. Select the ink cartridge information to be displayed, and then press the "OK" button. The information stored in the CSIC will be displayed.

CHAPTER

6

MAINTENANCE

6.1 Overview

This section provides information to maintain the printer in its optimum condition.

6.1.1 Cleaning

This printer has no mechanical components which require regular cleaning except the printhead. Therefore, when returning the printer to the user, check the following parts and perform appropriate cleaning if stain is noticeable.



- **Never use chemical solvents, such as thinner, benzine, and acetone to clean the exterior parts of printer like the housing. These chemicals may deform or deteriorate the components of the printer.**
- **Be careful not to damage any components when you clean inside the printer.**
- **Do not scratch the surface (coated part) of PF roller assembly. Use soft brush to wipe off any dusts. Use a soft cloth moistened with alcohol to remove the ink stain.**
- **Do not use cleaning sheet included in the media for normal usage. It may damage the coated surface of PF roller. If the adhesive surface of the cleaning sheet is set to the ASF LD roller side and used to clean the ASF LD roller surface, it is no problem.**

- Exterior parts
Use a clean soft cloth moistened with water and wipe off any dirt. If the exterior parts are stained with ink, use a cloth moistened with neutral detergent to wipe it off.
- Inside the printer
Use a vacuum cleaner to remove any paper dust.
- ASF LD Roller
If paper dust on the surface of ASF LD Roller lowers the friction, set the adhesive surface of the cleaning sheet included in the media to the surface of the ASF roller and repeat loading paper from the ASF.

6.1.2 Service Maintenance

If print irregularity (missing dot, white line, etc.) has occurred or the printer indicates “Maintenance Error”, take the following actions to clear the error.

□ Head Cleaning:

The printer has a built-in head cleaning function, which is activated by operating the control panel.

Confirm that the printer is in stand-by state (the POWER indicator is not blinking), and hold down the Error Reset SW on the control panel for more than 3 seconds.

The printer starts the cleaning sequence (The POWER indicator blinks during the cleaning sequence).

□ Maintenance Error Clear:

Ink is used for the operations such as cleaning as well as printing. Therefore, the printer wastes certain amount of ink and drains it into waste ink pad, while counting the amount of the waste ink. Once the amount of the waste ink reaches the predetermined limit, the printer indicates “Maintenance Error” and the waste ink pad should be replaced.

■ Overflow Counter Limit:

Overflow Counter (Protection Counter A) ≥ 39200

■ Timing for Replacing the Waste Ink Pad:

When the total amount of the waste ink reaches the predetermined limit, the LED indicates “Maintenance Error”. (Refer to Section 1.4.4 “Printer Conditions and Panel Status”)

Also, during repair servicing, check the ink counter along with the firmware version, ink counter, select code page, nozzle check pattern on the status printing sheet. If the ink counter value is close to its limit, notify your customer and recommend that the waste ink pad be replaced (If the waste ink pad is not replaced at that time, there is a possibility that “Maintenance Error” will occur soon after the printer is returned to the customer). Once you have the confirmation of the customer, replace the waste ink pad.

■ Replacement Procedure: Refer to Section 4.2.5.

■ After the Replacement:

Reset the Overflow Counter (Protection Counter A):

Power on printer with Error reset SW and Ink Cartridge exchange SW are pushed, and push Ink Cartridge exchange SW within error indicator is blinking

(3 seconds).

Refer to 1.4.3 “Panel Function” for details.

6.1.3 Lubrication

The characteristics of the grease have great affects on the mechanical function and durability, especially does the characteristics about temperature environment. The type and amount of grease used to lubricate the printer parts are determined based on the results of internal evaluations. Therefore, be sure to apply the specified type and amount of grease to the specified part of the printer mechanism during servicing.



- **Never use oil or grease other than those specified in this manual. Use of different types of oil or grease may damage the component or give bad influence on the printer function.**
- **Never apply larger amount of grease than specified in this manual.**

Table 6-1. Specified Lubricants

Type	Name	EPSON Code	Supplier
Grease	G-26	B702600001	EPSON
Grease	G55	1055459	EPSON

Table 6-2. Lubrication Point

No.	Lubrication Type/Point	Remarks
1	<p><Lubrication Point></p> <ul style="list-style-type: none"> Inside the CR shaft hole of the CR unit. Refer to Figure 6-1, "Lubrication point 1". <p><Lubrication Type></p> <ul style="list-style-type: none"> G-55 <p><Lubrication Amount></p> <ul style="list-style-type: none"> Whole inside the CR shaft hole evenly. 40+/15mg x 2 	<ul style="list-style-type: none"> Do not attach the grease to other portion of the CR unit. Use a syringe to apply it. Move the CR guide left and right, smooth out the Geese on the surface of the CR guide shaft. After lubrication, make sure that the carriage moves smoothly.
2	<p><Lubrication Point></p> <ul style="list-style-type: none"> Contact point between PF roller and the PF grounding spring. Refer to Figure , "". <p><Lubrication Type></p> <ul style="list-style-type: none"> G-26 <p><Lubrication Point></p> <ul style="list-style-type: none"> Φ1mm x 5mm 	<ul style="list-style-type: none"> Do not attach the grease to the paper path. Use a syringe to apply it.
3	<p><Lubrication Point></p> <ul style="list-style-type: none"> Shaft of the Pully driven shaft. Refer to Figure 6-3, "Lubrication point 3". <p><Lubrication Type></p> <ul style="list-style-type: none"> G-26 <p><Lubrication Amount></p> <ul style="list-style-type: none"> Φ1mm x 1mm 	<ul style="list-style-type: none"> Use a syringe to apply it.
4	<p><Lubrication Point></p> <ul style="list-style-type: none"> Inside the sliding slot for ASF Hopper on the ASF Frame. Refer to Figure 6-4, "Lubrication point 4". <p><Lubrication Type></p> <ul style="list-style-type: none"> G-26 <p><Lubrication Amount></p> <ul style="list-style-type: none"> Φ1mm x 4points 	<ul style="list-style-type: none"> Use a syringe to apply it. After lubrication, move the ASF hopper manually and smooth out the grease inside the ASF frame.

Table 6-2. Lubrication Point

No.	Lubrication Type/Point	Remarks
5	<p><Lubrication Point></p> <ul style="list-style-type: none"> Specified both edges area on the Front frame. Refer to Figure 6-5, "Lubrication point 5". <p><Lubrication Type></p> <ul style="list-style-type: none"> G-26 <p><Lubrication Amount></p> <ul style="list-style-type: none"> Φ1mm x 40mm x 2 areas 	<ul style="list-style-type: none"> Use a syringe to apply it. After lubrication, move the CR unit left or right and smooth out the grease on the Front frame.
6	<p><Lubrication Point></p> <ul style="list-style-type: none"> Between the Cam parts on the LD roller shaft and the ASF Hopper. Refer to Figure 6-6, "Lubrication point 6". <p><Lubrication Type></p> <ul style="list-style-type: none"> G-26 <p><Lubrication Amount></p> <ul style="list-style-type: none"> Φ1mm x 1mm 	<ul style="list-style-type: none"> The Cam parts on the LD roller shaft must touch the G-26 lubricated on the ASF hopper in the LD roller shaft rotation.

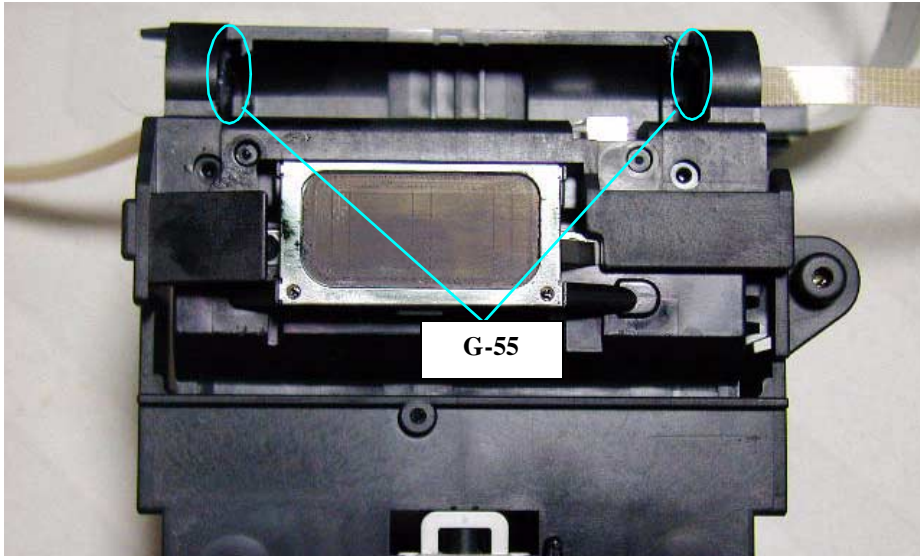

Figure 6-1. Lubrication point 1

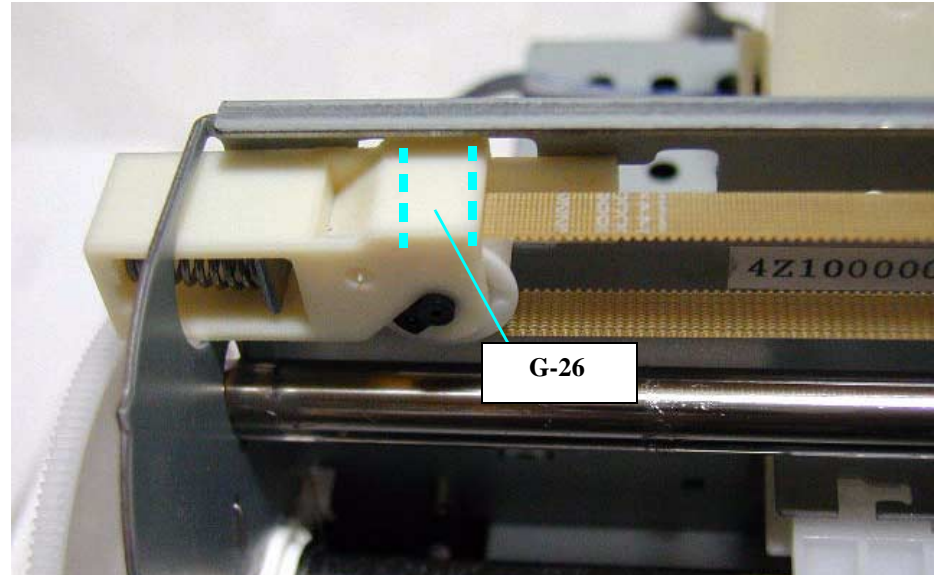

Figure 6-3. Lubrication point 3

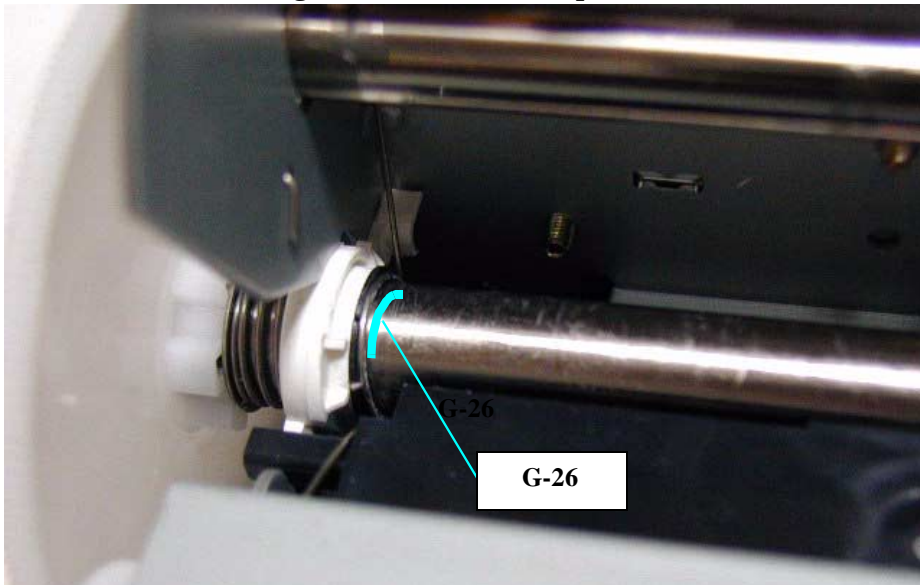

Figure 6-2. Lubrication point 2

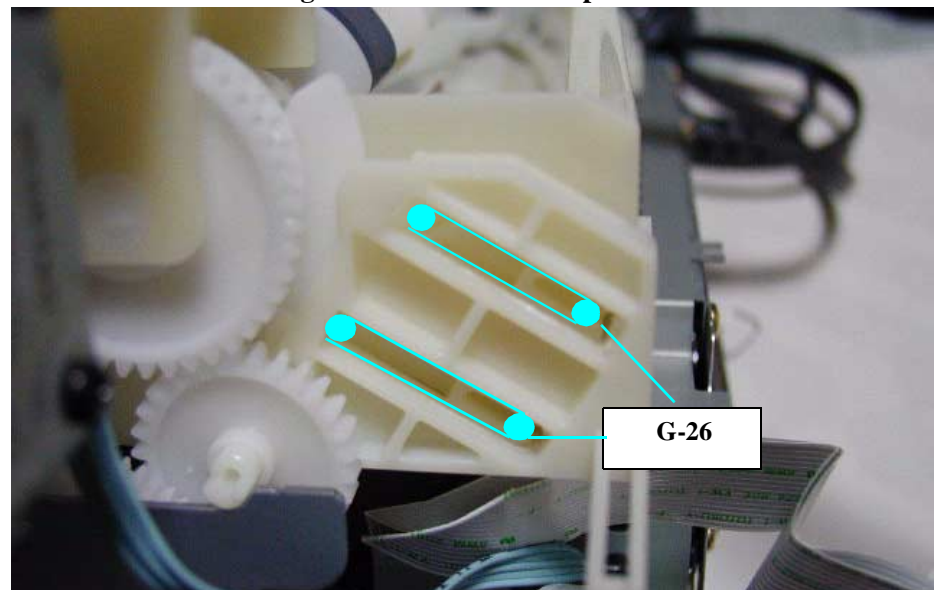

Figure 6-4. Lubrication point 4

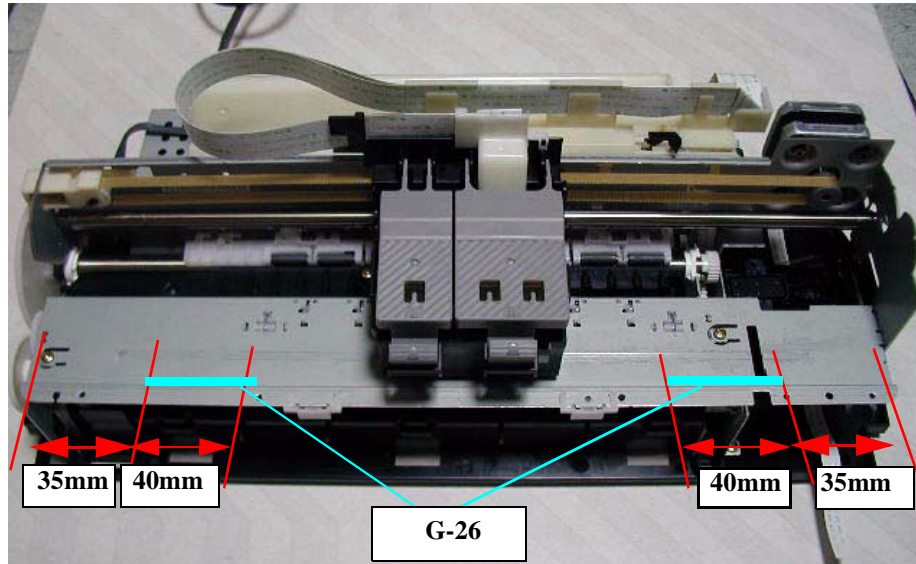

Figure 6-5. Lubrication point 5

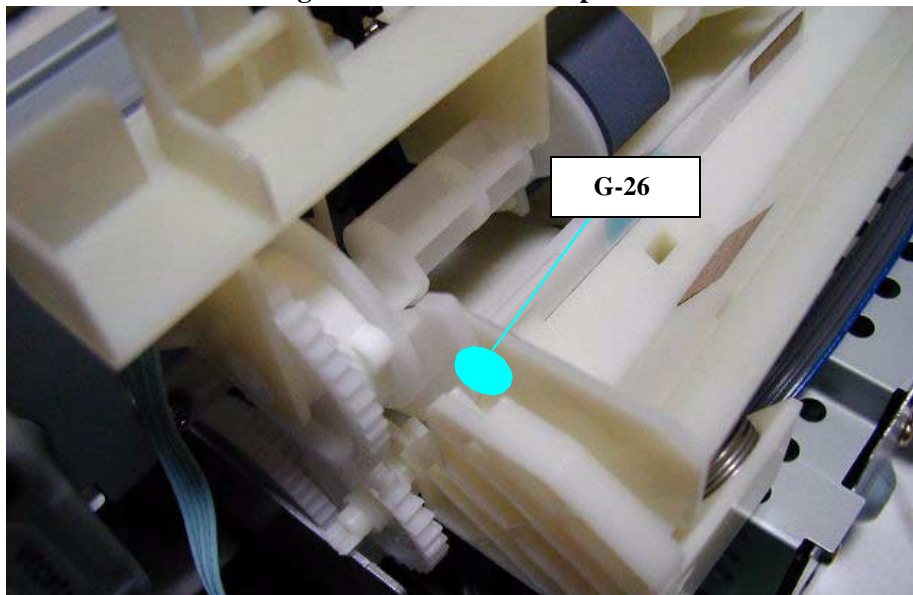

Figure 6-6. Lubrication point 6

CHAPTER

7

APPENDIX

7.1 Connector Summary

7.1.1 Major Component Unit

The Major component units of this printer are as follows.

- Main Board (C383MAIN)
- Power Supply Board (C383PSB/PSE)

The figure below shows how these components connect.

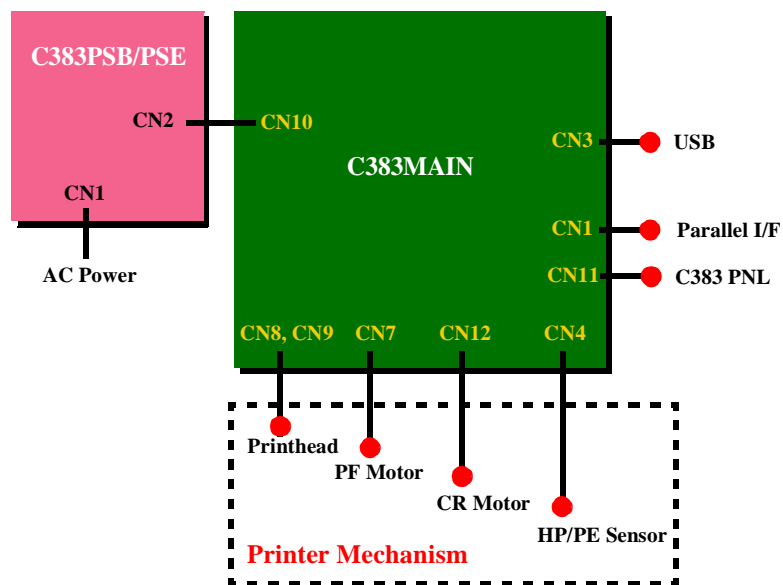

Figure 7-1. Connection of the Major Components

See the following tables for the connector summary for the C383MAIN board and each connector's pin alignment.

Table 7-1. Connector Summary for C383MAIN/MAIN-B

Connector	Function	Table to refer to
CN1	For connection with the parallel interface	Refer to "IEEE1284.4 Protocol" on page 19
CN3	For connection with the USB	Refer to "USB" on page
CN4	For connection with the HP/PE sensor	Table 7-2
CN7	For connection with the PF motor	Table 7-3
CN8, CN9	For connection with the printhead	Table 7-5
CN10	For connection with the power supply board	Table 7-6
CN11	For connection with the C383PNL board	Table 7-x
CN12	For connection with the CR motor	Table 7-8

Table 7-2. CN4 - HP/PE Sensor

Pin	Signal Name	I/O	Function
1	HPPE	In	Sensor detect signal
2	GND	---	Ground
3	HPPEV	---	Sensor Power Supply

Table 7-3. CN7 - PF Motor

Pin	Signal Name	I/O	Function
1	PFA	Out	Phase drive signal (A)
2	PFB	Out	Phase drive signal (-A)
3	PF-A	Out	Phase drive signal (B)
4	PF-B	Out	Phase drive signal (-B)

Table 7-4. CN8 - Printhead

Pin	Signal Name	I/O	Function
1	SI6	Out	Print data output (6)
2	SI5	Out	Print data output (5)
3	SI4	Out	Print data output (4)
4	GND	---	Ground
5	SCK	Out	Serial Clock
6	GND	---	Ground
7	CH	Out	Waveform selection signal for MS shot & Variable shot
8	COC	In	Color I/C detection signal
9	RXD	Out	CSIC output
10	COB	In	Black I/C detection signal
11	TXD	In	CSIC output
12	VDD3.3	---	Logic power supply (+3.3V)
13	GND	---	Ground
14	COM	---	Head drive pulse (trapezoid waveform)
15	GND	---	Ground
16	COM	---	Head drive pulse (trapezoid waveform)
17	GND	---	Ground

Table 7-5. CN9 - Printhead

Pin	Signal Name	I/O	Function
1	COM	---	Head drive pulse (trapezoid waveform)
2	GND	---	Ground
3	COM	---	Head drive pulse (trapezoid waveform)
4	GND	---	Ground
5	VHV	---	+42V power supply for nozzle selector
6	GND	---	Ground
7	SEL	In	Command select
8	GND	---	Ground
9	VDD	---	Logic power supply (+5V)
10	LAT	Out	Head data latch pulse output
11	GND	---	Ground
12	NCHG	Out	All nozzle fire selection pulse
13	THM	In	Thermistor detect signal
14	SI1	Out	Print data output (1)
15	SI2	Out	Print data output (2)
16	SI3	Out	Print data output (3)
17	SP	Out	select signal for CH signal

Table 7-6. CN10 - Power Supply Board

Pin	Signal Name	I/O	Function
1	+42V	---	Mechanism drive power supply
2	+42V	---	Mechanism drive power supply
3	GND	---	Ground
4	GND	In	Energy saving signal
5	NC	In	Not connected
6	GND	---	Ground
7	GND	---	Ground
8	+5V	---	Logic power supply

Table 7-7. CN11 - C383PNL

Pin	Signal Name	I/O	Function
1	SW3	In	Panel switch on/off (3)
2	SW2	In	Panel switch on/off (2)
3	GND	---	Ground
4	+5V	---	Logic power supply
5	LED0	Out	LED drive signal (0)
6	LED3	Out	LED drive signal (3)
7	PSC	In	Power on/off switch
8	SW1	In	Panel switch on/off (1)

Table 7-8. CN12 - CR Motor

Pin	Signal Name	I/O	Function
1	CRA	Out	Phase drive signal (A)
2	CRB	Out	Phase drive signal (-A)
3	CR-A	Out	Phase drive signal (B)
4	CR-B	Out	Phase drive signal (-B)

7.1.2 EEPROM Address Map

Table 7-9. EEPROM Address Map

Address	Explanation	Setting	QPIT setting	Factory setting
00H	Ink flag1	Bit7: CSIC Disable Bit6: black one-time Bit5: color one-time Bit4: Initial charge required Bit3: Reserved Bit2: ink cleaning seq. Bit1: black CL required Bit0: color CL required	00H	10H
01H	Ink flag2	Bit7: Reserved Bit6: Black 1st Ink Cartridge Bit5: Color 1st Ink Cartridge Bit4: Bk CSIC changed Flag1 Bit3: YMC CSIC changed Flag1 Bit2: Reserved Bit1: Reserved Bit0: Reserved	00H	00H
02H 05H	Ink counter Cb 00H		00H 00H	00H 00H
06H 09H	Ink counter Cy 00H		00H 00H	00H 00H
0AH 0DH	Ink counter Cm		00H 00H	00H 00H
0EH 11H	Ink counter Cc		00H 00H	00H 00H

Table 7-9. EEPROM Address Map (continued)

Address	Explanation	Setting	QPIT setting	Factory setting
12H 15H	Ink counter Clm		00H 00H	00H 00H
16H 19H	Ink counter Clc		00H 00H	00H 00H
1AH	Ink counter A0		00H	00H*3
1BH			00H	00H*3
1CH	Ink counter Rb0		00H	00H*3
1DH			00H	00H*3
1EH	Ink counter Ry0		00H	00H*3
1FH			00H	00H*3

Table 7-9. EEPROM Address Map (continued)

Address	Explanation	Setting	QPIT setting	Factory setting
20H	CL time		00H	-
21H			00H	-
22H	CPU Time		00H	00H*2
23H			00H	00H*2
24H	accumulated printing time		00H	00H
25H			00H	00H
26H	D4mode I/F	Bit7: I/F Control Flag Bit6:	05H	05H
		Bit5: Reserved Bit4:		
		Bit3: D4mode USB Bit2:		
		Bit1: D4mode Parallel Bit0:		
27H	Initial Charge Counter		00H	00H
28H	ERROR Code		00H	00H
29H	Reserved		00H	00H
2AH	Reserved		00H	00H
2BH	Reserved		00H	00H
2CH	Reserved		00H	00H
2DH	Reserved		00H	00H
2EH	Reserved		00H	00H
2FH	Reserved		00H	00H

data in 00h ~ 2Fh are written to EEPROM at NMI

Address	Explanation	Setting	QPIT setting	Factory setting
30H	Interface selection	Bit7: Reserved Bit6: Reserved Bit5: Reserved Bit4: Reserved Bit3: USB Bit2: Reserved Bit1: Parallel Bit0: Auto	00H	00H*2
31H	Interface time-out	0 to 255 (by second, value of 0 means 10seconds)	0AH	0AH
32H	I/F Speed	Bit7: Reserved Bit6: Bit5: Reserved Bit4: Bit3: ECP speed Bit2: Bit1: Compatibility speed Bit0:	00H	00H
33H	Bi-D Adjustment for MultiShot (Bk)	-72<=n<=+72(by 1/2880inch)	00H (*1)	00H (*1)
34H	Bi-D Adjustment for 6plVSD (Bk)	-72<=n<=+72 (by 1/2880inch)	00H (*1)	00H (*1)
35H	Bi-D Adjustment for 4plVSD (Bk)	-72<=n<=+72 (by 1/2880inch)	00H (*1)	00H (*1)
36H	Bi-D Adjustment for MultiShot (Cl)	-72<=n<=+72 (by 1/2880inch)	00H (*1)	00H (*1)
37H	Bi-D Adjustment for 6plVSD (Cl)	-72<=n<=+72 (by 1/2880inch)	00H (*1)	00H (*1)
38H	Bi-D Adjustment for 4plVSD (Cl)	-72<=n<=+72 (by 1/2880inch)	00H (*1)	00H (*1)

Address	Explanation	Setting	QPIT setting	Factory setting
39H	1stDot Position Adjustment	-72<=n<=+72 (by 1/2880inch)	00H (*1)	00H (*1)
3AH	CL2 Counter KK			
3BH	Total Timer CL			

Address	Explanation	Setting	QPIT setting	Factory setting
3CH	Printer For CSIC		00H	8:R4C62 10 9:R4C64 90
3DH	CSIC1_InkName1;		00H	
3EH	CSIC2_InkName1;			
3FH	Head Actuator Rank ID for VhN	+1<=n<=+32	00H	(*1)
40H	Head Actuator Rank ID for VhM	+1<=n<=+37 00H	00H	(*1)
41H	Head Actuator Rank ID for VhL	+1<=n<=+34 00H	00H	(*1)
42H	Head Actuator Rank ID for VhU	+1<=n<=+40 00H	00H	(*1)
43H	Head Actuator Rank ID for VhM2	+1<=n<=+34 00H	00H	(*1)
44H	Head Actuator Rank ID for VhB	+1<=n<=+34 00H	00H	(*1)
45H	Head Actuator Rank ID for AR	0<=n<=+6 00H	00H	(*1)
46H	Head Actuator Rank ID for IwB	+30<=n<=+70 00H	00H	(*1)
47H	Head Actuator Rank ID for IwC	+30<=n<=+70 00H	00H	(*1)
48H	Head Actuator Rank ID for IwM	+30<=n<=+70 00H	00H	(*1)
49H	Head Actuator Rank ID for IwY	+30<=n<=+70 00H	00H	(*1)
4AH	Head Actuator Rank ID for IwLC	+30<=n<=+70 00H	00H	(*1)

Address	Explanation	Setting	QPIT setting	Factory setting
4BH	Head Actuator Rank ID for IwLM	+30<=n<=+70 00H	00H	(*1)
4CH 5DH	USB ID		00H 00H	(*1) (*1)
5EH	Market ID	0:EURO/ASIA:Stylus COLOR 680 1:EAI:Stylus COLOR 777 2:Custom	00H	EURO/ A SIA:00H EAI:01 H
5FH	Reserved			
60H 7DH	Model Name		00H 00H	- -
7EH	Password		55H	55H
7FH	Password		33H	33H

NOTE:

*1 Adjusted at factory.

*2 Initialized after performed panel initialization of EEPROM.

*3 Initialized after performed panel initialization of the ink overflow.

7.2 Component Layout

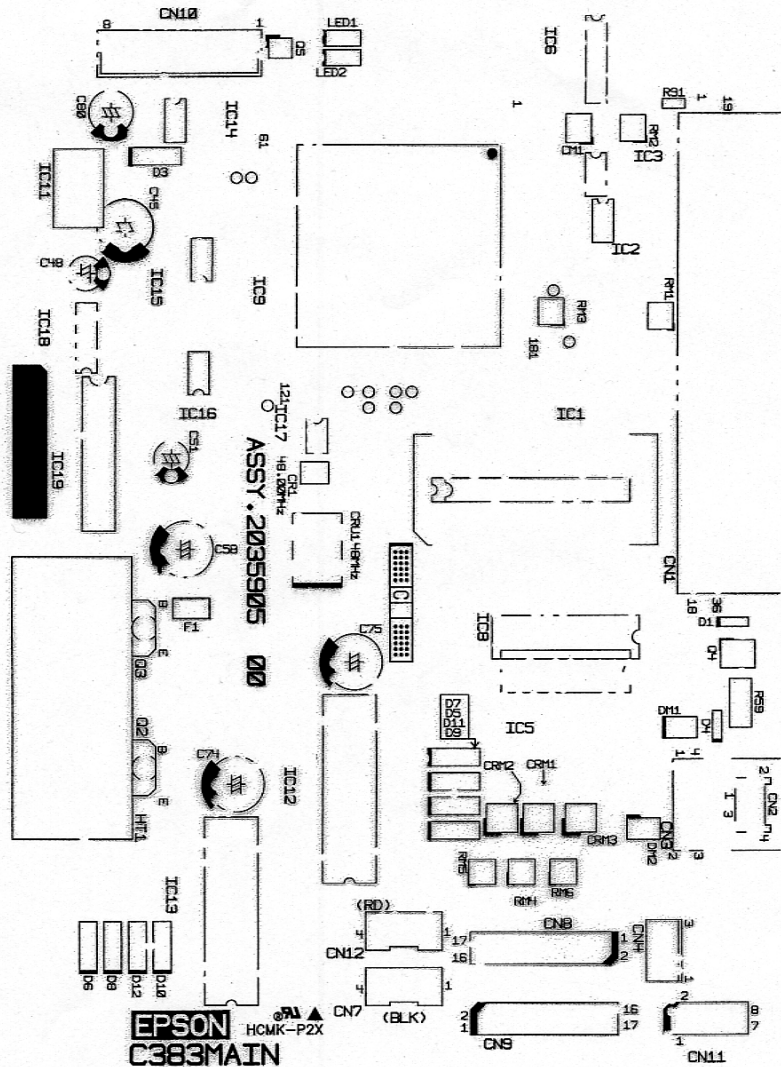

Figure 7-2. C383MAIN Component Layout (Parts Side)

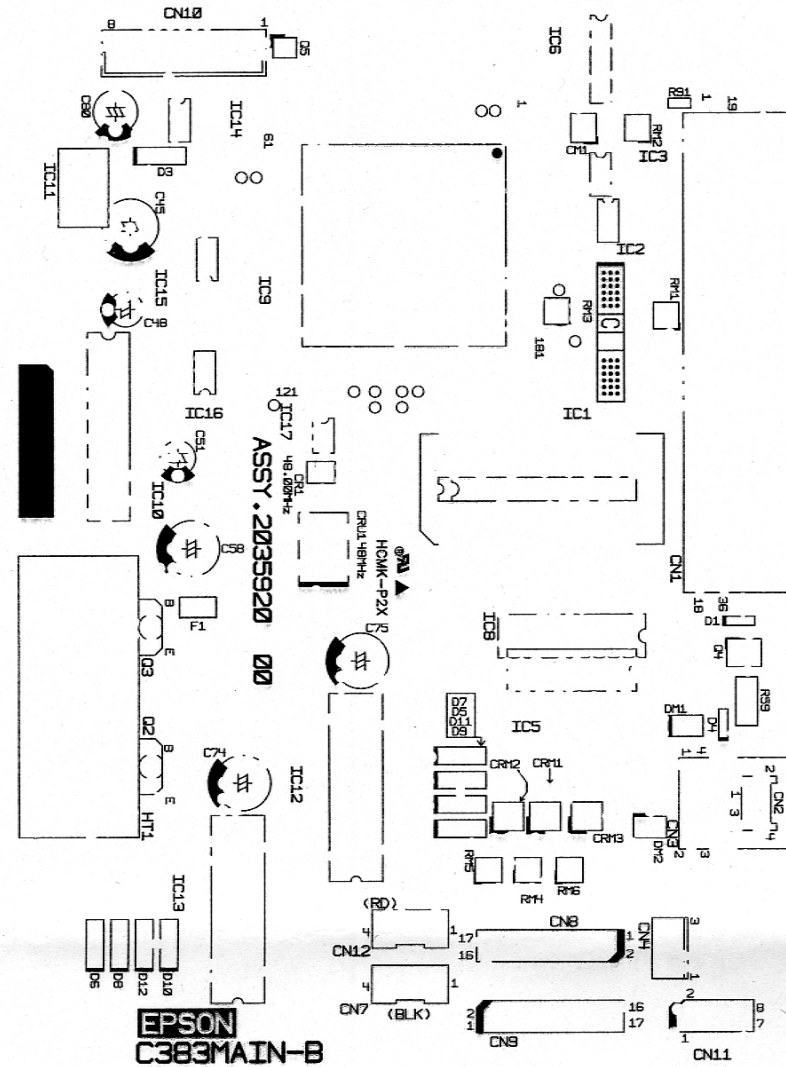

Figure 7-3. C383 MAIN B Component Layout

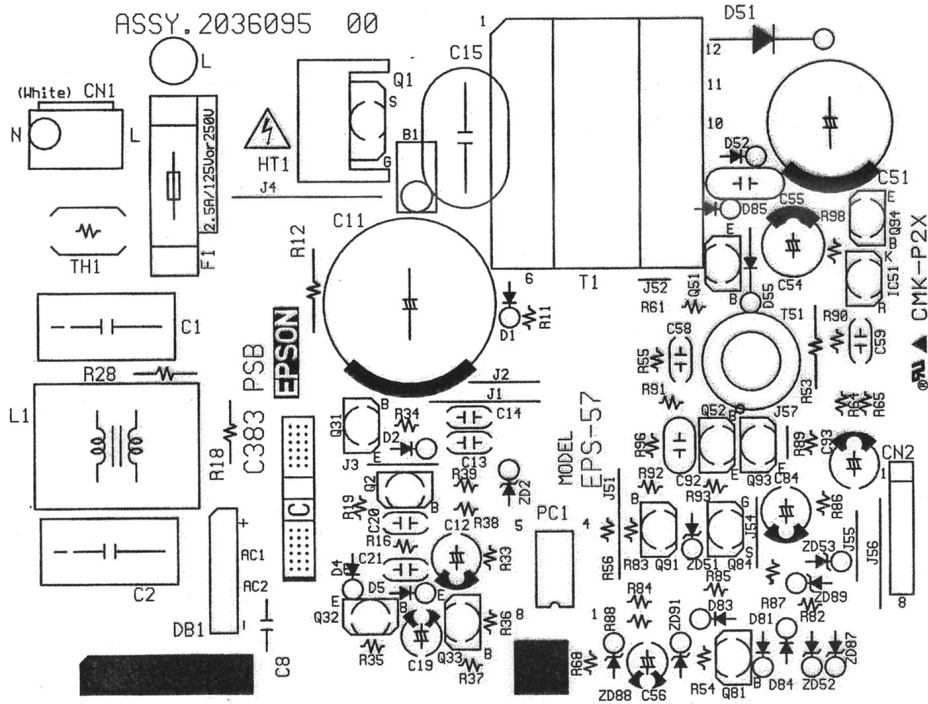

Figure 7-4. C383PSB Component Layout

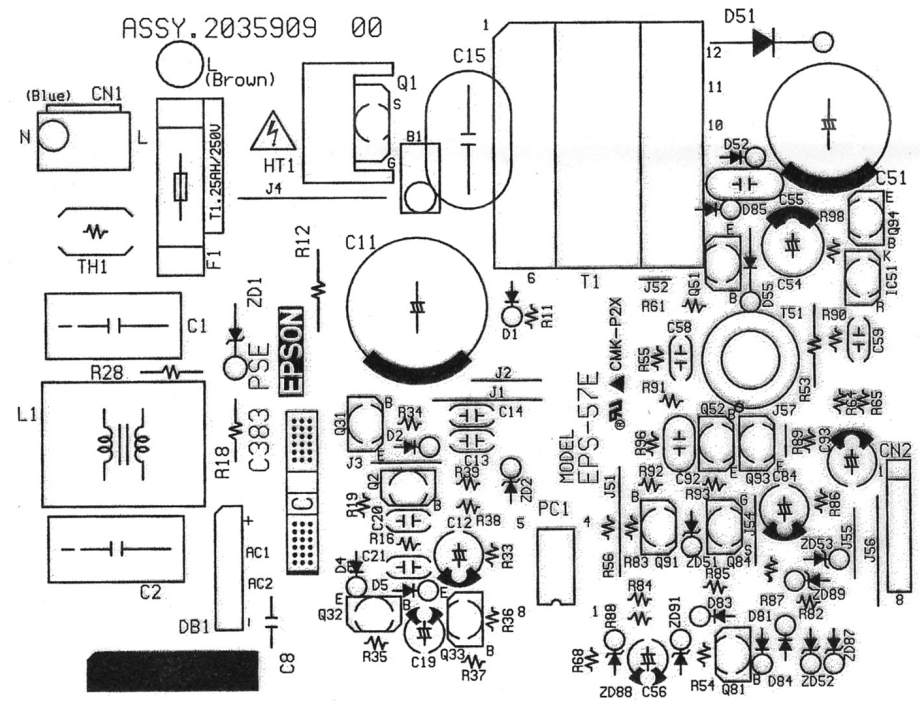

Figure 7-5. C383PSE Component Layout

7.3 Exploded Diagram

Following pages show exploded diagram.

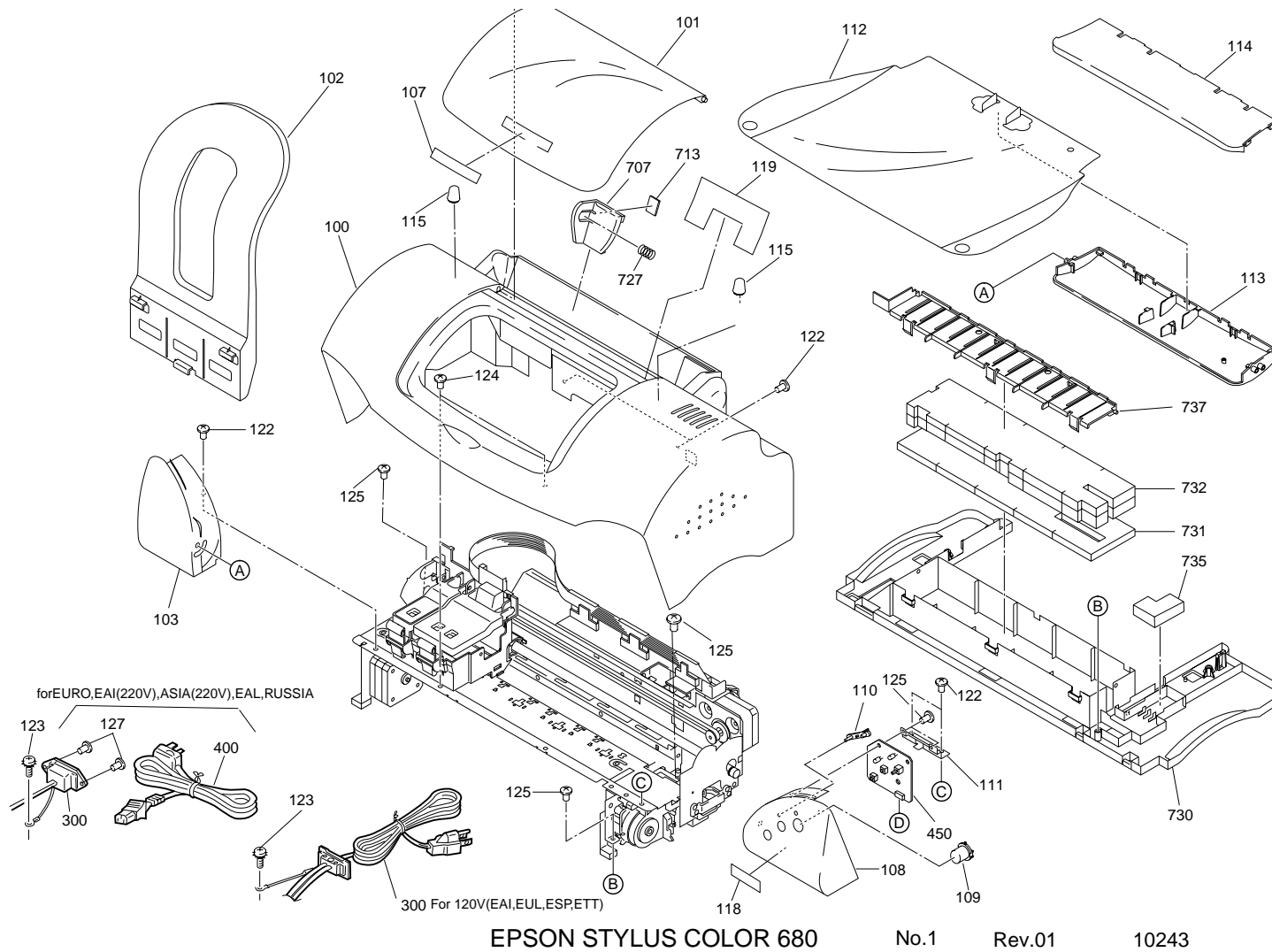
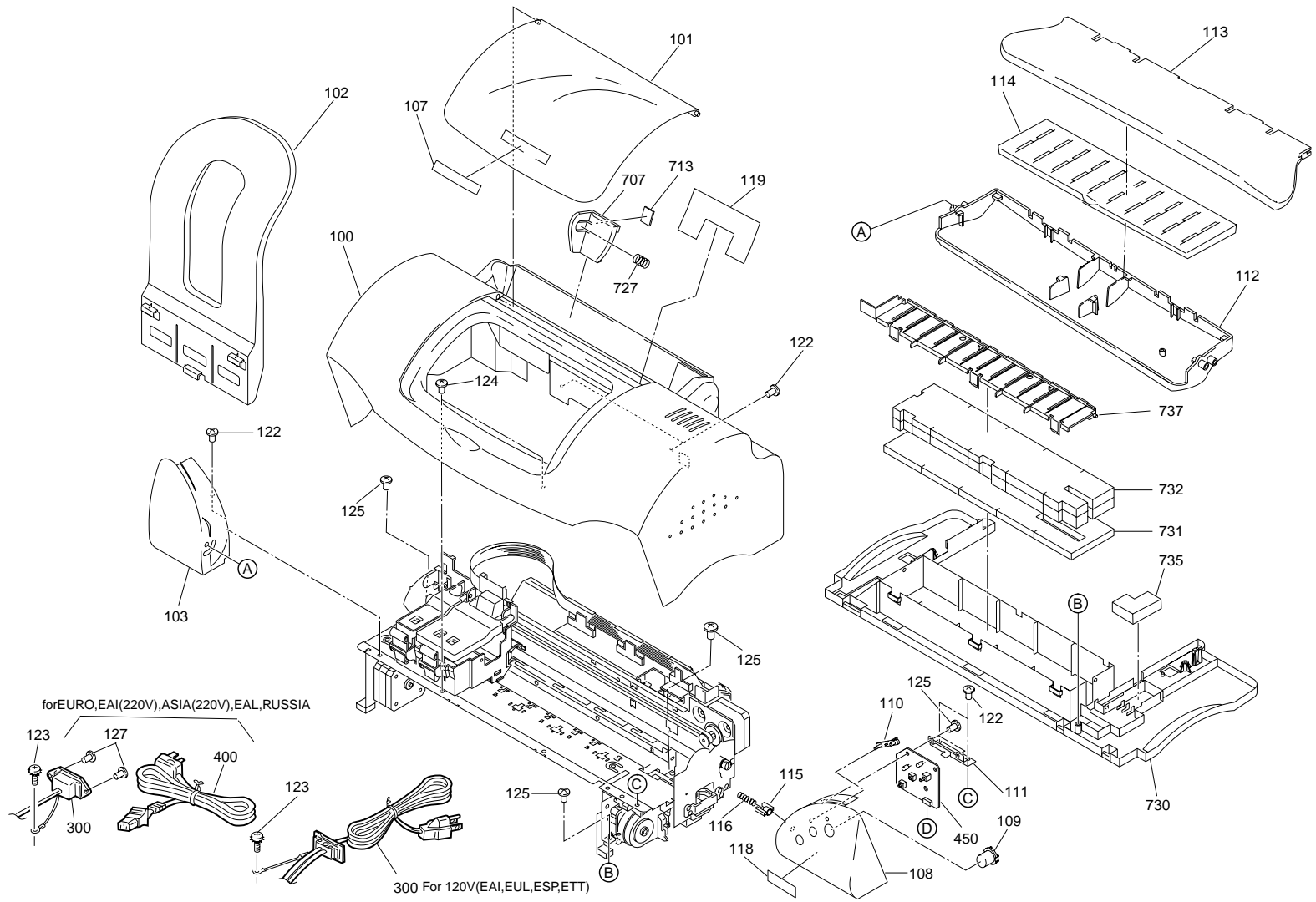
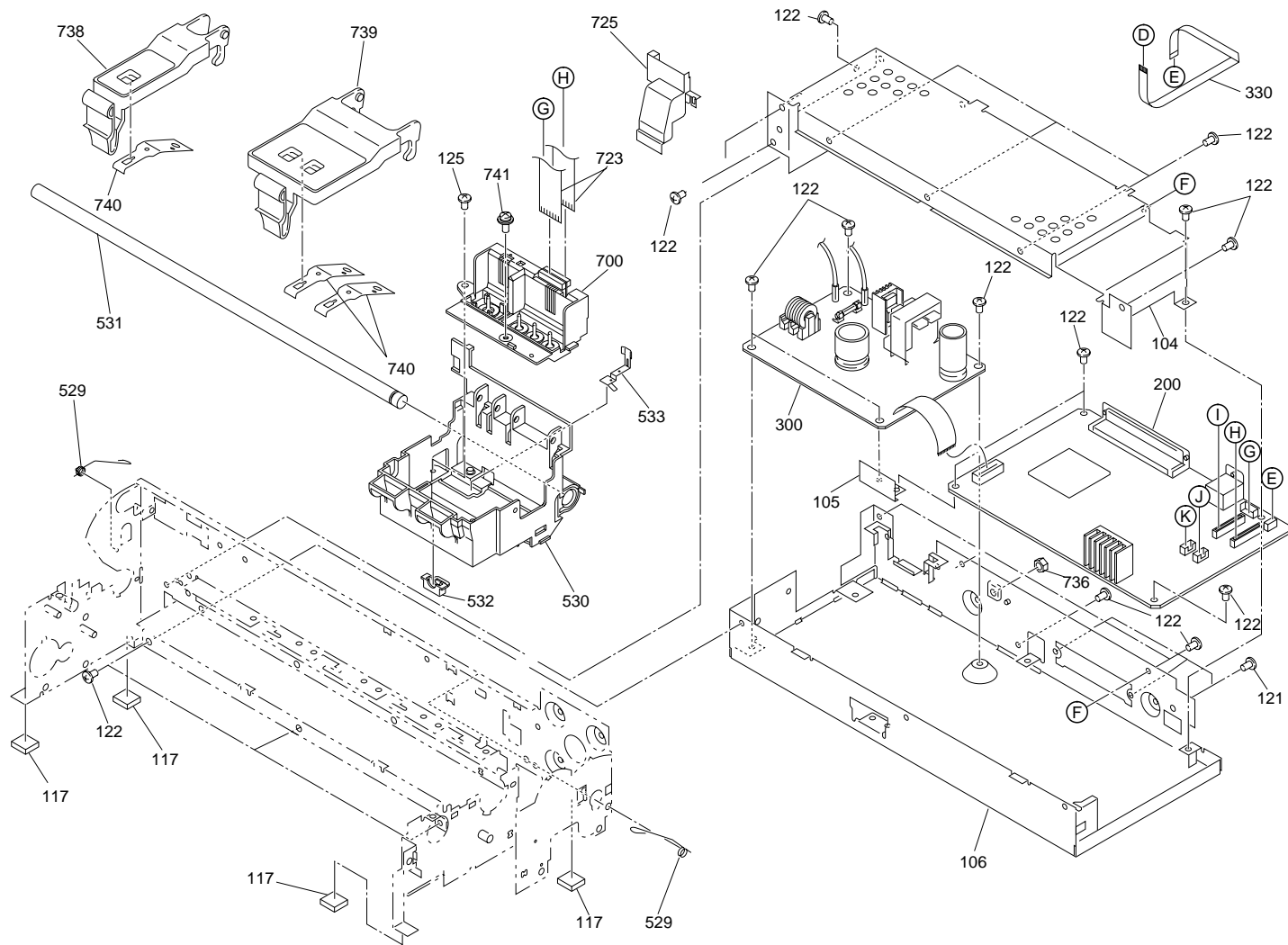

Figure 7-6. Stylus Color 680 Exploded Diagram 1



EPSON STYLUS COLOR 777 No.1 Rev.01 10243

Figure 7-7. Stylus Color 777 777i Exploded Diagram 1



EPSON STYLUS COLOR 777/680

No.2

Rev.01

10243

Figure 7-8. Stylus Color 680/777/777i Exploded Diagram 2

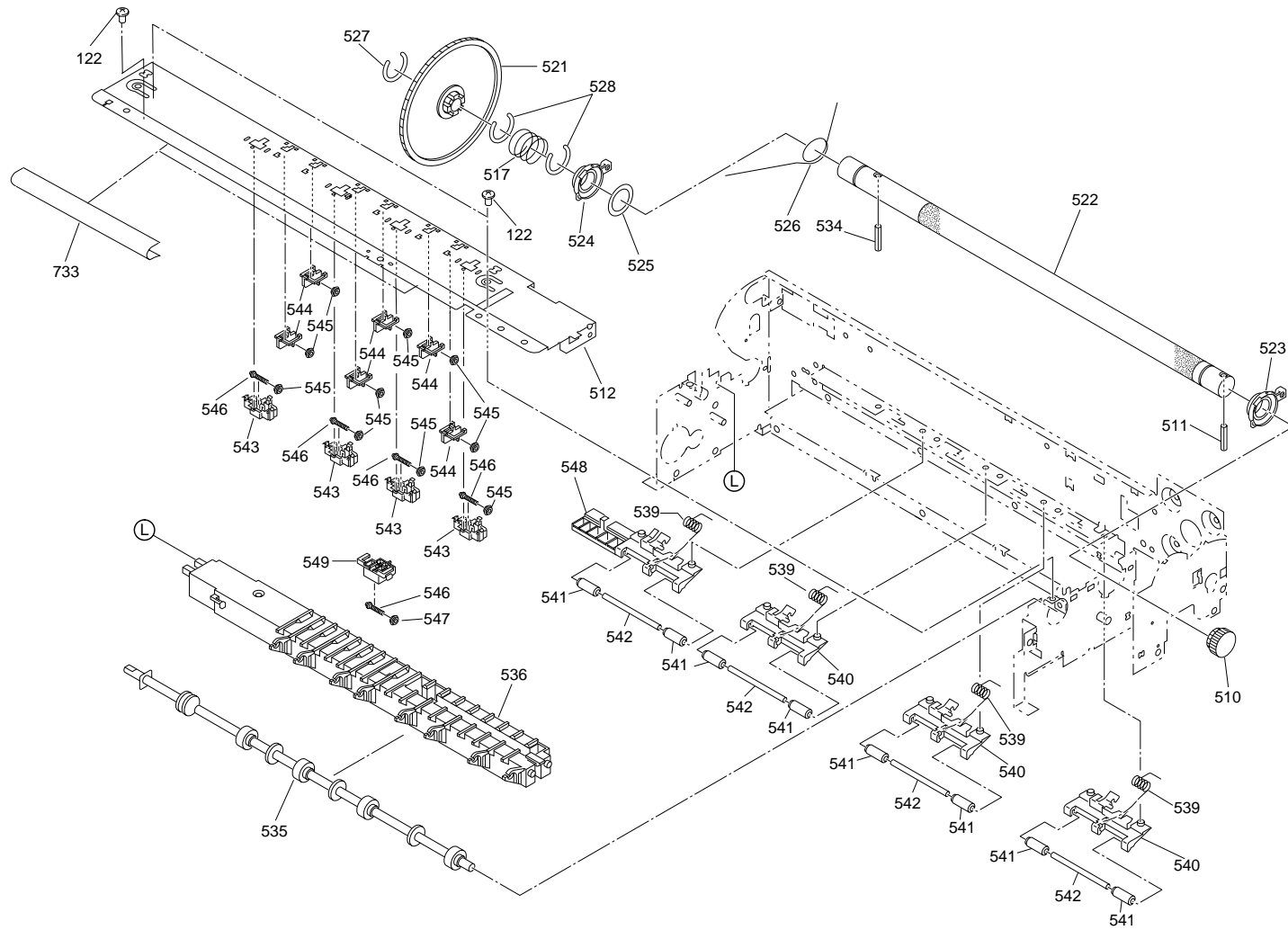

EPSON STYLUS COLOR 777/680 No.3 Rev.01 10243
Figure 7-9. Stylus Color 680/777/777i Exploded Diagram 3s

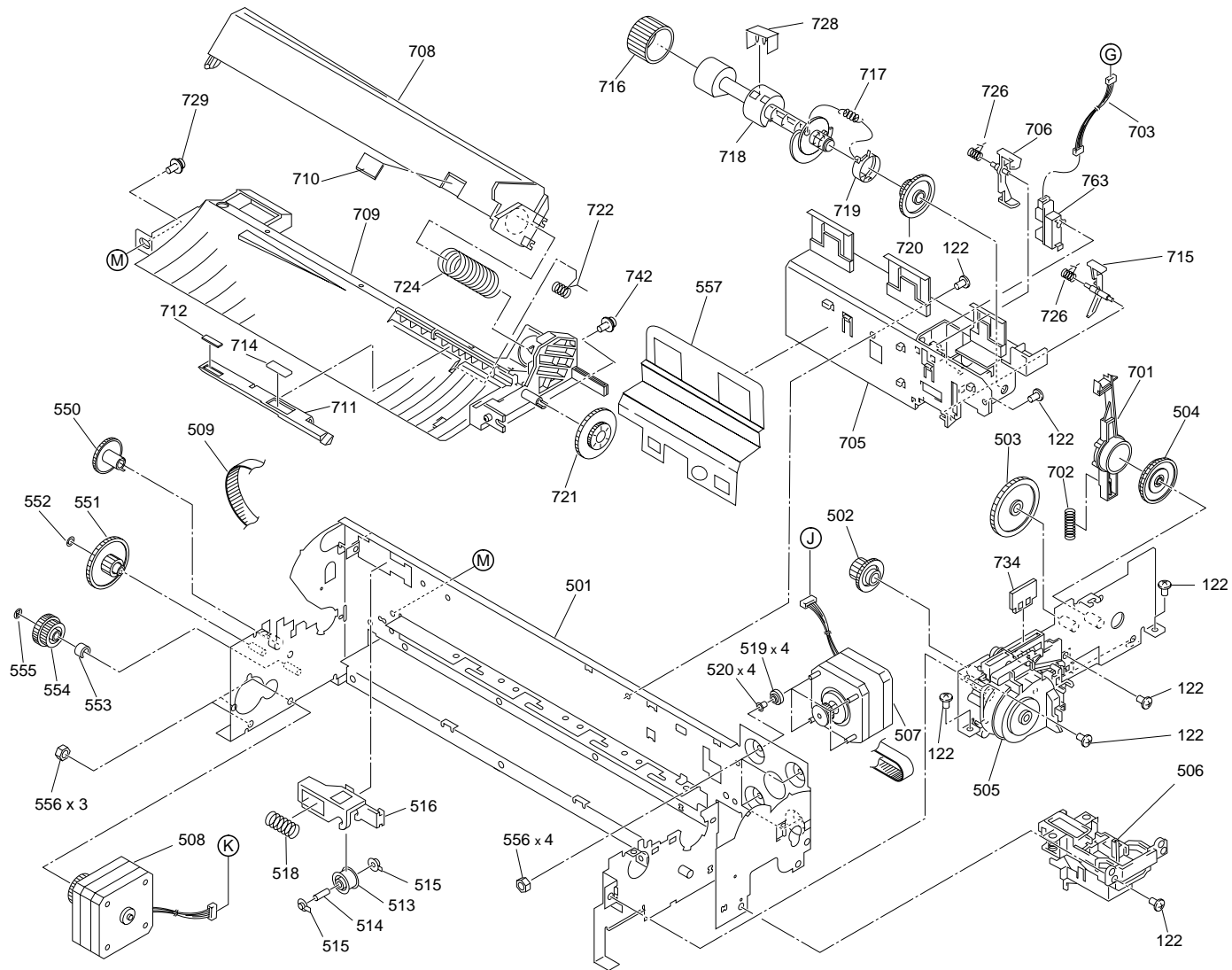

EPSON STYLUS COLOR 777/680 No.4 Rev.01 10243

Figure 7-10. Style Clor 680/777/777i Exploded Diagram 4

7.4 Parts List

Table 7-10. Stylus COLOR 680/777/777i Parts List

Code	Parts Name
100	HOUSING
101	COVER,PRINTER
102	PAPERSUPPORT
103	HOUSING,SUPPORT,LEFT
104	SHIELDPLATE,UPPER
105	COVER,SHIELD PLATE,LEFT
106	SHIELD PLATE,M/B;B
107	LOGO PLATE
109	FOOT
110	GROUNDING,PLATE
122	C.B.S. SCREW
123	C.B.(O) SCREW,4X5,F/ZG
124	C,B,S-TITE R.SCREW,3X6,F/UC
125	C.B.P-TITE SCREW,3X8,F/ZN
200	BOARD ASSY., MAIN
C37	ALUMINIUM ELECTROLYTIC CAPACITOR
C39	ALUMINIUM ELECTROLYTIC CAPACITOR
C40	ALUMINIUM ELECTROLYTIC CAPACITOR
C41	ALUMINIUM ELECTROLYTIC CAPACITOR
C45	ALUMINIUM ELECTROLYTIC CAPACITOR
C48	ALUMINIUM ELECTROLYTIC CAPACITOR
C64	ALUMINIUM ELECTROLYTIC CAPACITOR

Table 7-10. Stylus COLOR 680/777/777i Parts List

Code	Parts Name
CN1	CONNECTOR
CN2	CONNECTOR
CN3	CONNECTOR
CN4	CONNECTOR
CN6	CONNECTOR 57RE-40360-830B(D7B)
CR2	CERAMIC CRYSTAL
D1	DIODE
D2	DIODE
D3	DIODE
D4	DIODE
D5	DIODE
D6	DIODE
D7	DIODE
D8	DIODE
F1	FUSE
HT1	HEAT SINK
IC10	TTL-IC
IC3	EP-ROM
IC3	IC SOCKET
IC4	DRAM
IC5	EEPROM,AT93C46-10SC
IC6	RESET IC
IC7	IC
IC8	HIC
IC9	HIC

Table 7-10. Stylus COLOR 680/777/777i Parts List

Code	Parts Name
Q1	C.B.SCREW,2.6X6,F/ZN
Q1	TRANSISTOR
Q2	C.B.SCREW,2.6X6,F/ZN
Q2	TRANSISTOR
300	BOARD ASSY.,POWER SUPPLY
501	FRAME,MAIN
502	REINFORCEMENT PLATE,HOLDER
503	HOLDER,MOTOR ASSY.,CR
504	COMPRESSIONSPRING,15.7
505	PUMP ASSY.
506	CAP ASSY.
507	MOTOR ASSY.,CR
508	MOTOR ASSY.,PF
509	TIMINGBELT
510	SPUR GEAR,15
511	SPRINGPIN,2X14.5
512	FRAME,FRONT
513	PULLEY,DRIVEN
514	SHAFT,PULLEY,DRIVEN
515	SPUR GEAR,34.2
516	COMBINATION GEAR,12.6,18.4
517	COMPRESSION SPRING,5.85
518	SPURGEAR,15.2
519	COMBINATION GEAR,8.4,21.6
520	COMBINATION GEAR,9.6,33.6

Table 7-10. Stylus COLOR 680/777/777i Parts List

Code	Parts Name
521	SPACER,C-RING
522	ROLLER,PF
523	BUSHING,ROLLER,PF
524	BUSHING,ROLLER,PF,LEFT
525	SPACER,FASTEN,ROLLER,PF
526	GROUNDING WIRE,ROLLER,PF
527	C-RING
528	PLANE WASHER,12.2X0.5X15
529	RODSRING,SHAFT,CR,GUIDE
530	CARRIAGE
531	SHAFT,CR,GUIDE
532	SLIDER,CR
533	GROUNDINGPLATE,HEAD
534	SPUR GEAR,15,EJ
535	ROLLER,EJECT
536	PAPERGUIDE,ERONT
537	COVER,CARTRIDGE,BK
538	COVER,CARTRIDGE,C
539	TORSION SPRING,52.92
540	PAPERGUIDE,UPPER
541	ROLLER,DRIVEN
542	SHAFT,ROLLER,DRIVEN
543	HOLDER,STARWHEEL,FRONT
544	HOLDER,STARWHEEL,REAR
545	STARWHEEL ASSY.,8;E

Table 7-10. Stylus COLOR 680/777/777i Parts List

Code	Parts Name
546	ROD SPRING,STAR WHEEL
547	C.C.S.SCREW
548	PAPERGUIDE,LEFT
549	SPACER,COVER CARTRIDGE
700	PRINT HEAD
701	LEVER,CHANGE
702	COMPRESSION SPRING,0.98
703	HARNES,DETECTOR
704	DETECTOR,HP;C
705	HOLDER,SHAFT
706	LEVER,DETECTOR,HP
707	EDGEGUIDE
708	HOPPER
709	FRAME,ASF
710	PAD,HOPPER
711	HOLDER,PAD
712	PAD,LD,SMALL
713	PAD,BRAKE,EDGE GUIDED
714	PAD,LD,C
715	LEVER,DETECTOR,PE
716	ROLLER,LD
717	EXTENSION SPRING,0.143
718	SHAFT,ROLLER,LD
719	CLUTCH
720	SPUR GEAR,35.2

Table 7-10. Stylus COLOR 680/777/777i Parts List

Code	Parts Name
721	COMBINATION GEAR,11.2,32.4
722	COMBINATION GEAR,22.4,32
723	CABLE,HEAD;B
724	COMPRESSION SPRING,4.80
725	TORSIONSPRING,25.7
726	TORSIONSPRING,0.22
727	COMPRESSION SPRING 3.75
728	SHAFT,ROLLER,LD,SUPPORT
729	C.P.S-TITE(P4),3X6,F/ZN
730	TRAY,POROUSPAD
731	POROUSPAD,INKEJECT,LARGE
732	POROUSPAD,INKEJECT,SMALL
733	SHEET,PROTECTION;D
734	CLEANER, HEAD ASP
735	FERRITE CORE
736	HEXAGON NUT
1	INDIVIDUAL CARTON BOX FOR AMERICA
3	PAD PRINTER
4	PLASTIC PROTECTIVE BAG,360X680X0.03T
NON FIG	INK CARTRIDGE,B,OVERSEAS,AS
NON FIG	INK CARTRIDGE,C,OVERSEAS,AS
NON FIG	SOFTWARE CD-ROM,EAI
NON FIG	USER'S GUIDE
NON FIG	SETTING UP MANUAL

7.5 Electrical Circuits

The electric circuit diagrams below are shown at the following pages:

- C383MAIN control circuit board
- C383MAIN-B control circuit board
- C383PSB power supply circuit board
- C380PSE power supply circuit board

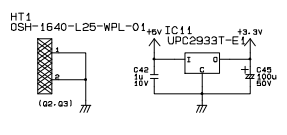
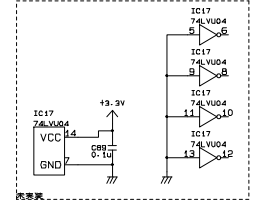
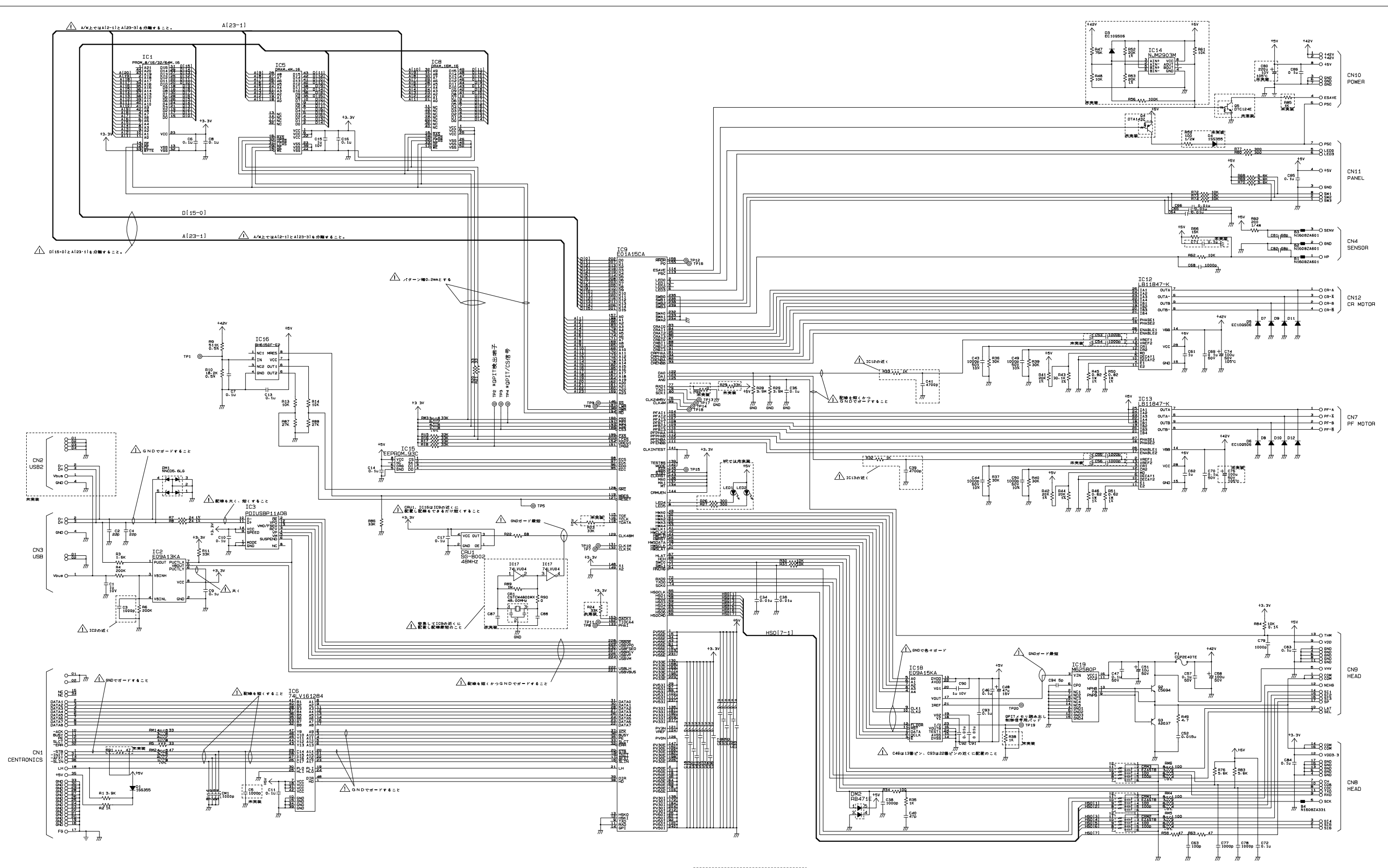

MODEL: SC 680 / 777 / 777i
 BOARD: C383MAIN BORAD
 SHEET: 1/1
 REV. C

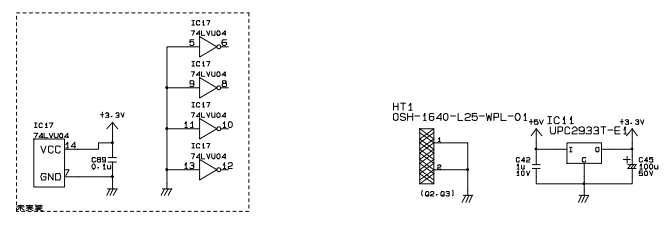
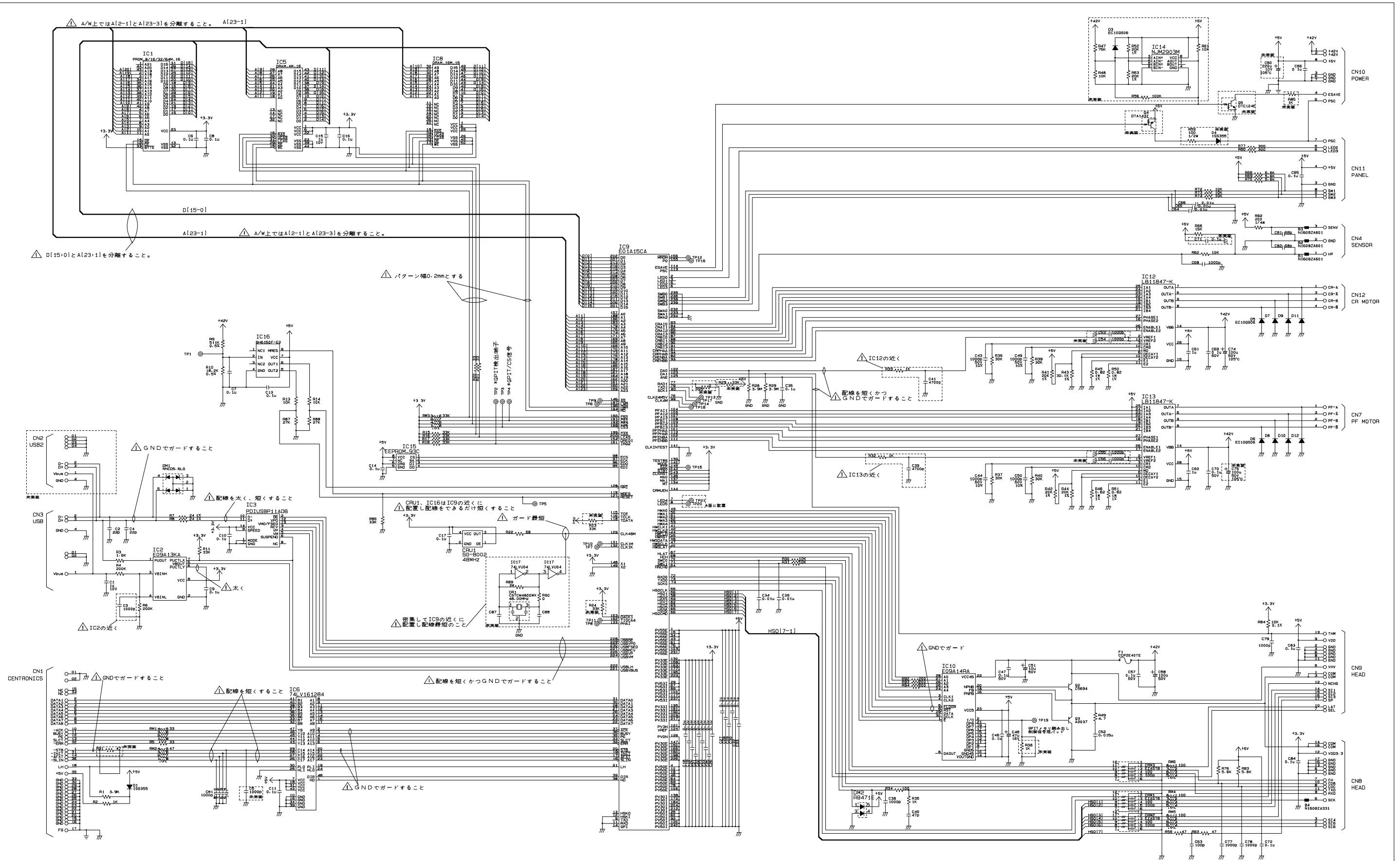

MODEL: SC 680 / 777 / 777i
 BOARD: C383MAIN-B BORAD
 SHEET: 1/1
 REV. C

A

B

C

D

E

F

G

H

1

2

3

4

5

6

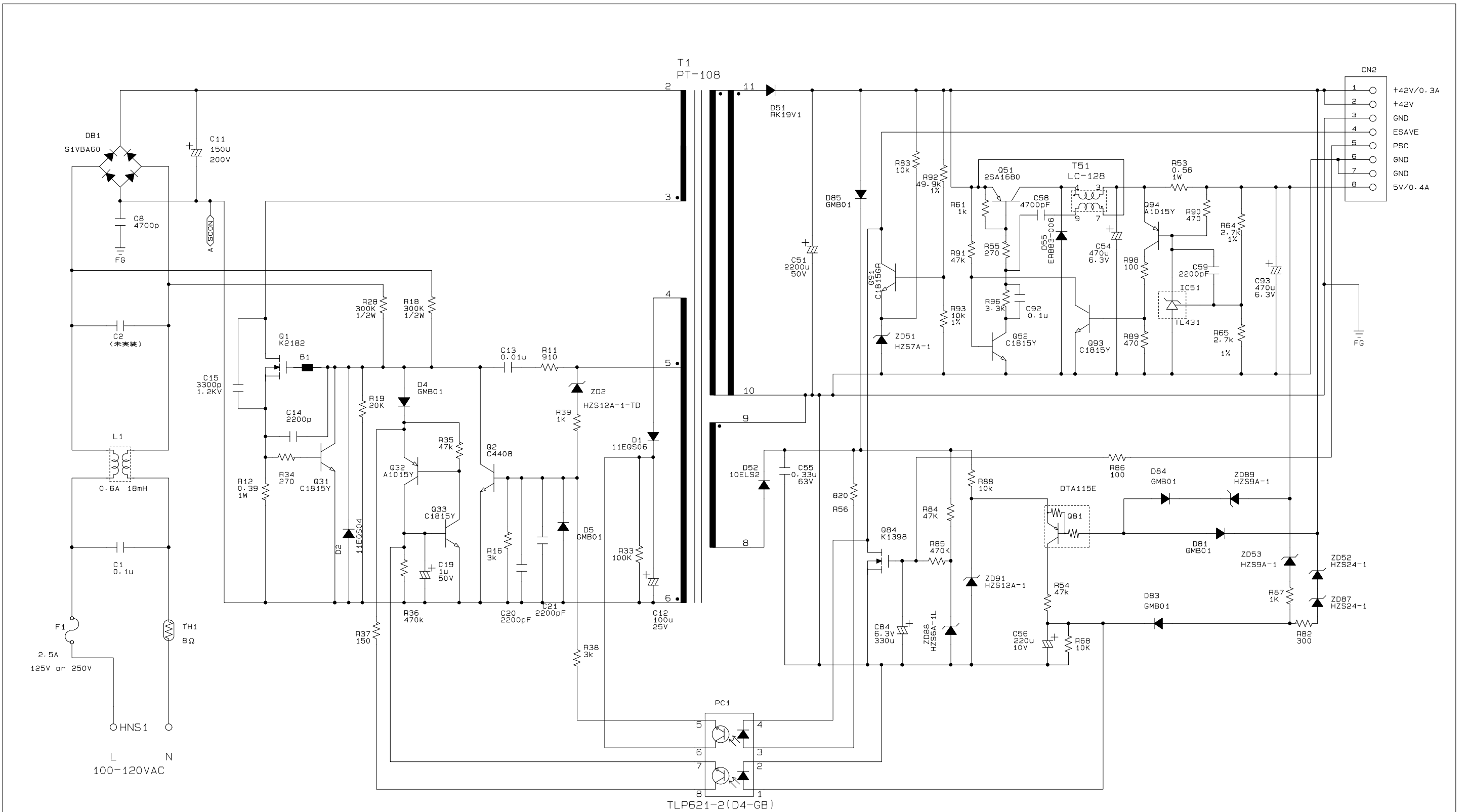

MODEL : SC 680 / 777 / 777i
 BOARD : C383PSB BORAD
 SHEET : 1/1
 REV. C

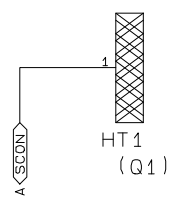

TLP621-2(D4-GB)

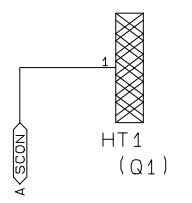
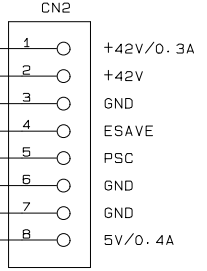
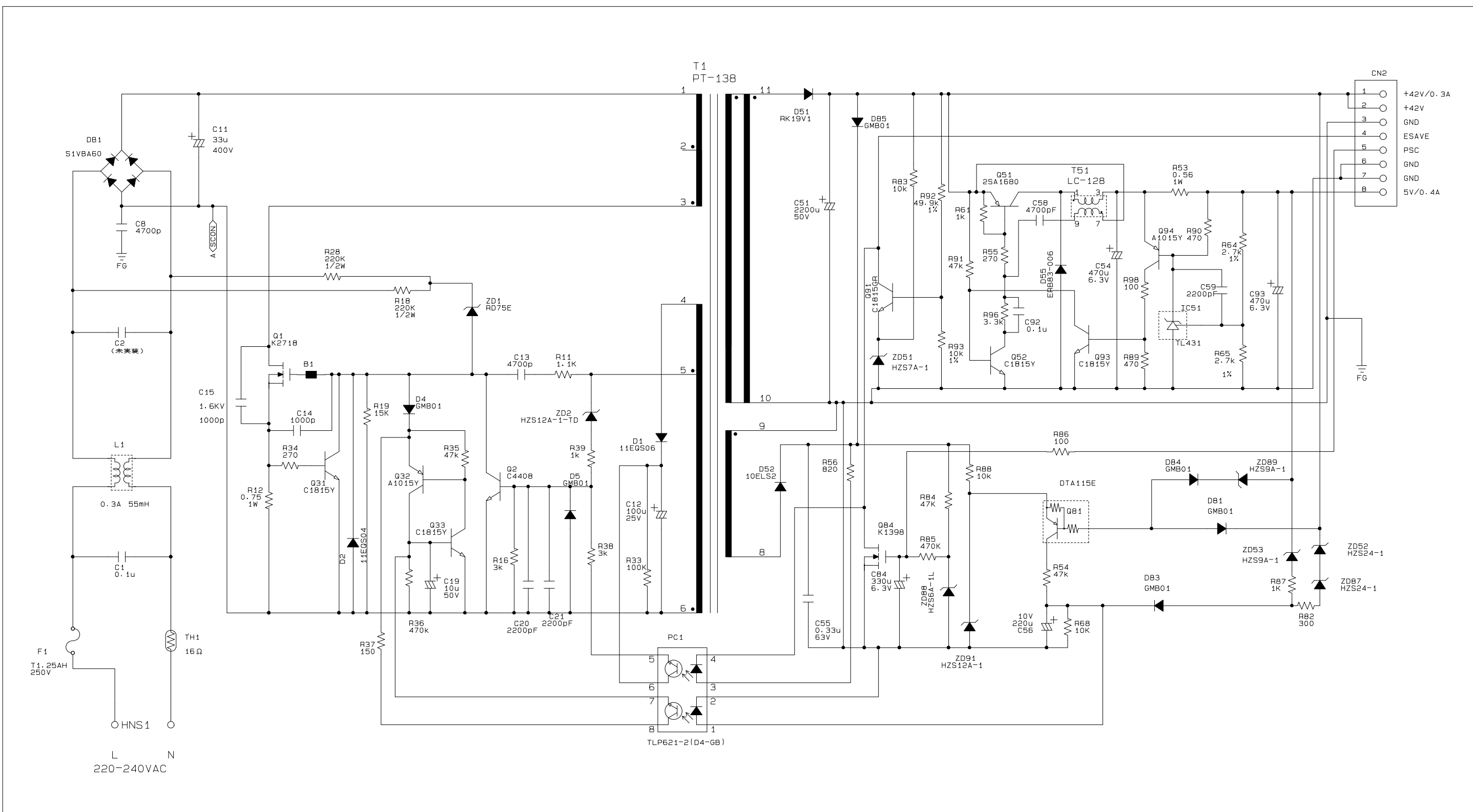

MODEL: SC 680 / 777 / 777i
 BOARD: C383PSE BORAD
 SHEET: 1/1
 REV. D